



KÜP SERİSİ
Cube Series



KÜP SERİSİ
Cube Series



CB100

ÜRÜN KODU
Product Code
CB100

ÜRÜN ADI
Product Name
Küp Serisi

YAŞ ARALIĞI
Ages
5-12

KAPASİTE
Number of User
45

DÜŞME YÜKSEKLİĞİ
Fall Height (mm)
3500

TEPE YÜKSEKLİĞİ
Hill Height (mm)
6000

OTURMA ALANI
Settle Area (mm)
8000x12000

GÜVENLİK ALANI
Safety Area (mm)
1200x16000



KÜP SERİSİ
Cube Series

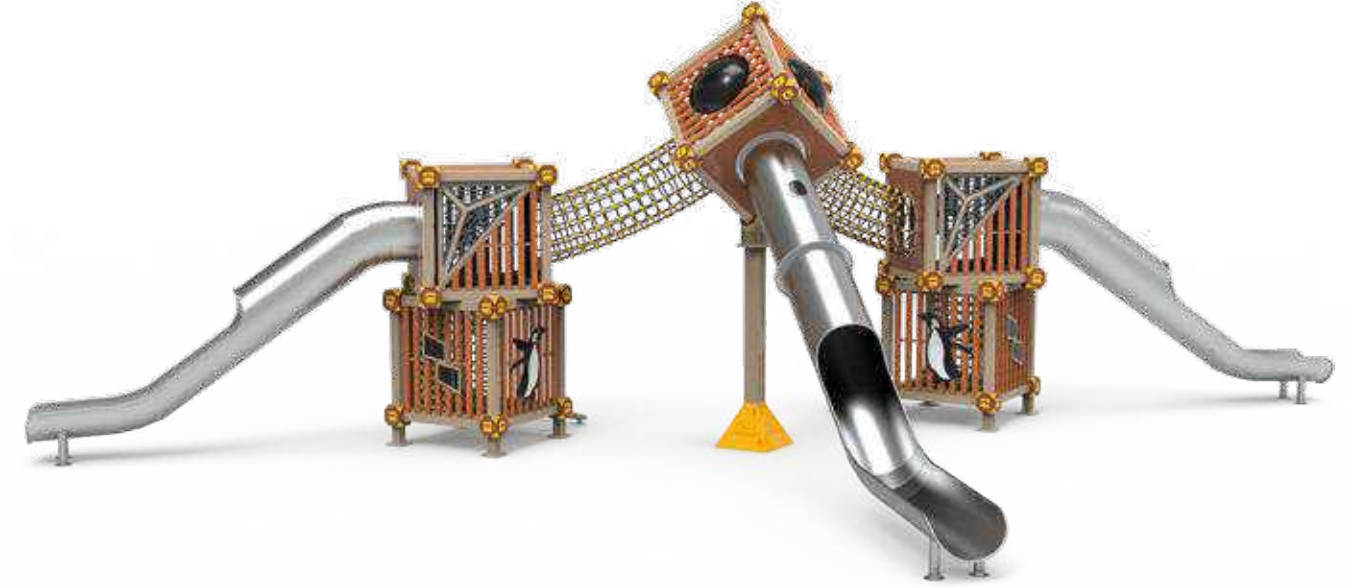

KÜP SERİSİ
Cube Series

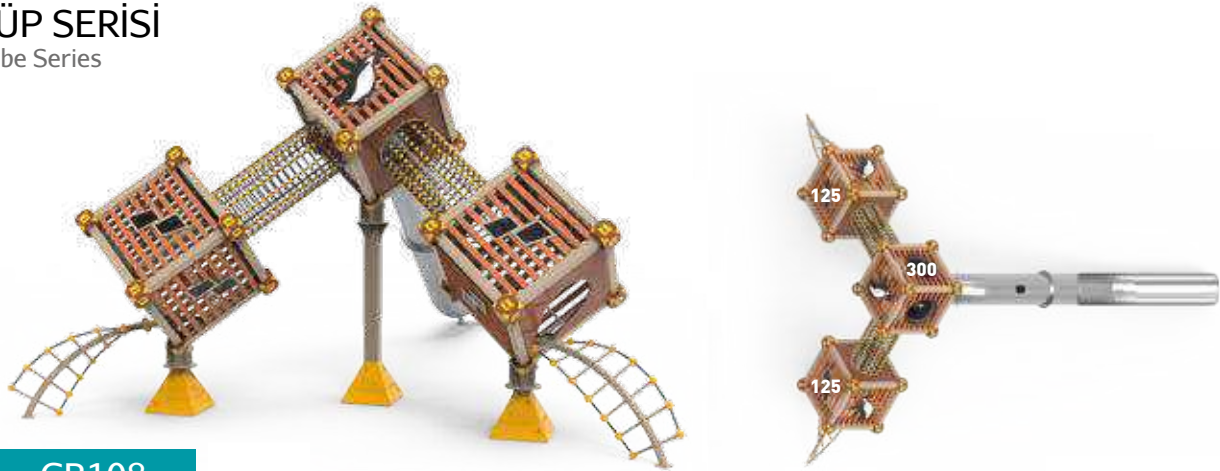

CB108

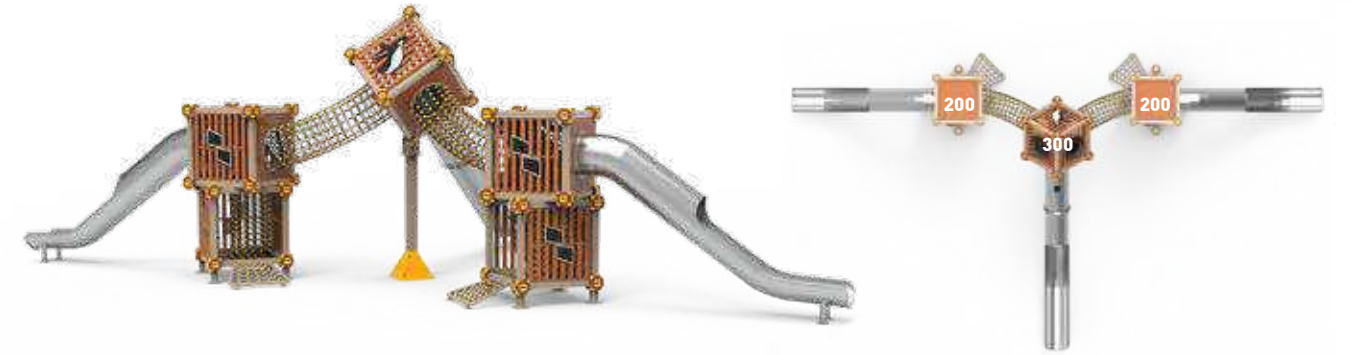

CB109

ÜRÜN KODU
Product Code
CB108

YAŞ ARALIĞI
Ages
5-12

DÜŞME YÜKSEKLİĞİ
Fall Height (mm)
3000

OTURMA ALANI
Settle Area (mm)
8500x10300

ÜRÜN ADI
Product Name
Küp Serisi

KAPASİTE
Number of User
40

TEPE YÜKSEKLİĞİ
Hill Height (mm)
5500

GÜVENLİK ALANI
Safety Area (mm)
12500x14300

ÜRÜN KODU
Product Code
CB109

YAŞ ARALIĞI
Ages
5-12

DÜŞME YÜKSEKLİĞİ
Fall Height (mm)
3000

OTURMA ALANI
Settle Area (mm)
9650x17300

ÜRÜN ADI
Product Name
Küp Serisi

KAPASİTE
Number of User
47

TEPE YÜKSEKLİĞİ
Hill Height (mm)
5500

GÜVENLİK ALANI
Safety Area (mm)
13650x21300



KÜP SERİSİ
Cube Series

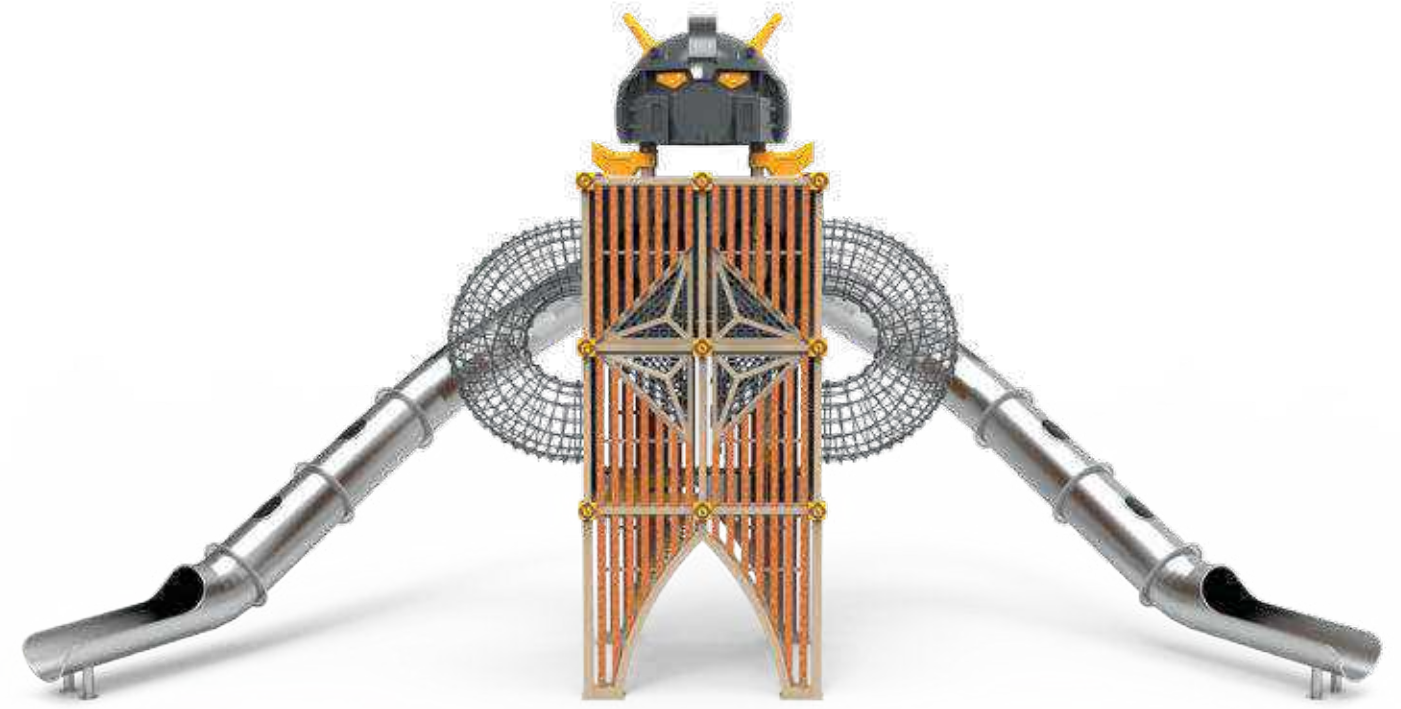

KÜP SERİSİ
Cube Series



CB110

CB111



ÜRÜN KODU
Product Code
CB110

YAŞ ARALIĞI
Ages
5-12

DÜŞME YÜKSEKLİĞİ
Fall Height (mm)
3000

OTURMA ALANI
Settle Area (mm)
13400x13700

ÜRÜN ADI
Product Name
Küp Serisi

KAPASİTE
Number of User
50

TEPE YÜKSEKLİĞİ
Hill Height (mm)
5500

GÜVENLİK ALANI
Safety Area (mm)
17400x17700

ÜRÜN KODU
Product Code
CB111

YAŞ ARALIĞI
Ages
7-14

DÜŞME YÜKSEKLİĞİ
Fall Height (mm)
3650

OTURMA ALANI
Settle Area (mm)
5300x14000

ÜRÜN ADI
Product Name
Küp Serisi

KAPASİTE
Number of User
45

TEPE YÜKSEKLİĞİ
Hill Height (mm)
7000

GÜVENLİK ALANI
Safety Area (mm)
9300x18000



KÜP SERİSİ
Cube Series



CB112

ÜRÜN KODU
Product Code
CB112

YAŞ ARALIĞI
Ages
7-14

DÜŞME YÜKSEKLİĞİ
Fall Height (mm)
3650

OTURMA ALANI
Settle Area (mm)
6500x19500

ÜRÜN ADI
Product Name
Küp Serisi

KAPASİTE
Number of User
102

TEPE YÜKSEKLİĞİ
Hill Height (mm)
7000

GÜVENLİK ALANI
Safety Area (mm)
10500x23500



KÜP SERİSİ
Cube Series



CB113



ÜRÜN KODU
Product Code
CB113

YAŞ ARALIĞI
Ages
7-14

DÜŞME YÜKSEKLİĞİ
Fall Height (mm)
7500

OTURMA ALANI
Settle Area (mm)
14650x19400

ÜRÜN ADI
Product Name
Küp Serisi

KAPASİTE
Number of User
107

TEPE YÜKSEKLİĞİ
Hill Height (mm)
11650

GÜVENLİK ALANI
Safety Area (mm)
18650x23400

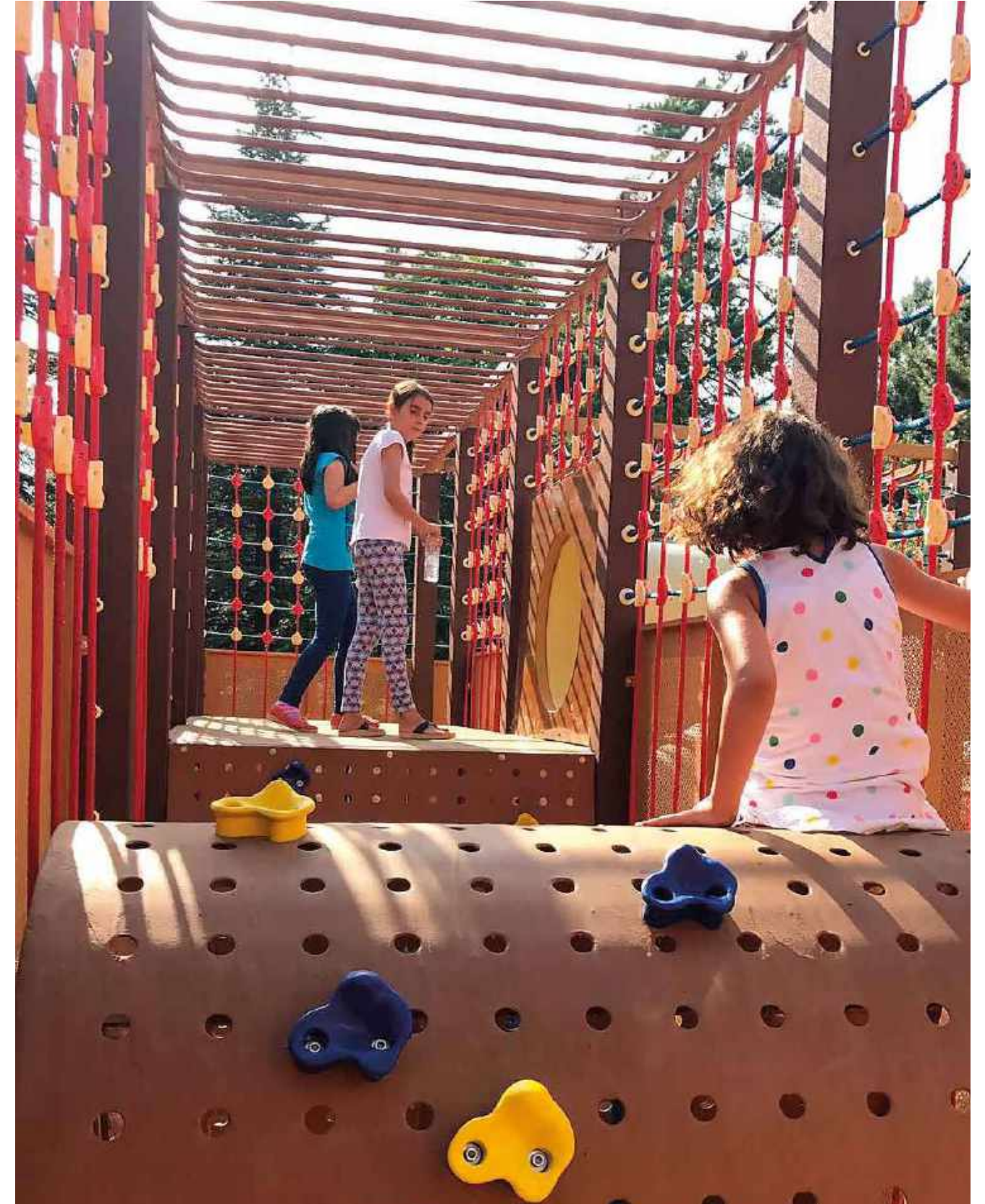

KAFES SERİSİ
Cage Series



KAFES SERİSİ

Cage Series



CG201

ÜRÜN KODU
Product Code
CG201

YAŞ ARALIĞI
Ages
5-12

DÜŞME YÜKSEKLİĞİ
Fall Height (mm)
3000

OTURMA ALANI
Settle Area (mm)
5100x10000

ÜRÜN ADI
Product Name
Kafes Serisi

KAPASİTE
Number of User
120

TEPE YÜKSEKLİĞİ
Hill Height (mm)
5000

GÜVENLİK ALANI
Safety Area (mm)
9100x14000



CG202

ÜRÜN KODU
Product Code
CG202

YAŞ ARALIĞI
Ages
7-14

DÜŞME YÜKSEKLİĞİ
Fall Height (mm)
4000

OTURMA ALANI
Settle Area (mm)
13250x43500

ÜRÜN ADI
Product Name
Kafes Serisi

KAPASİTE
Number of User
175

TEPE YÜKSEKLİĞİ
Hill Height (mm)
6000

GÜVENLİK ALANI
Safety Area (mm)
17250x47500



KAFES SERİSİ
Cage Series



CG203

ÜRÜN KODU
Product Code
CG203

YAŞ ARALIĞI
Ages
7-14

DÜŞME YÜKSEKLİĞİ
Fall Height (mm)
4000

OTURMA ALANI
Settle Area (mm)
9750x18400

ÜRÜN ADI
Product Name
Kafes Serisi

KAPASİTE
Number of User
96

TEPE YÜKSEKLİĞİ
Hill Height (mm)
6000

GÜVENLİK ALANI
Safety Area (mm)
13750x22400



BAL TOPU SERİSİ
Honey Ball Series

BAL TOPU SERİSİ
Honey Ball Series

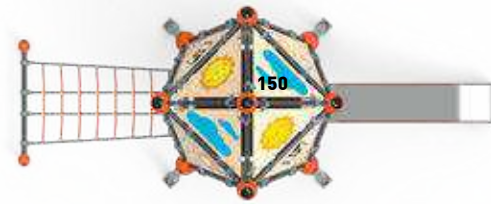

HNB3300



BAL TOPU SERİSİ
Honey Ball Series

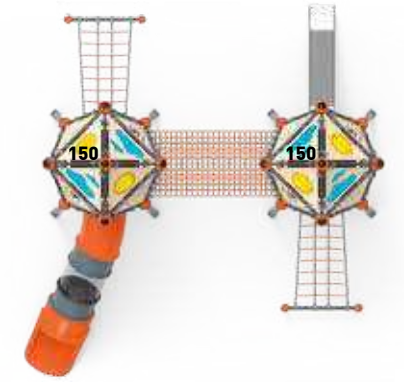

HNB3301

ÜRÜN KODU
Product Code
HNB3300

YAŞ ARALIĞI
Ages
5-12

DÜŞME YÜKSEKLİĞİ
Fall Height (mm)
1500

OTURMA ALANI
Settle Area (mm)
2300x5500

ÜRÜN ADI
Product Name
Bal Topu Serisi

KAPASİTE
Number of User
15

TEPE YÜKSEKLİĞİ
Hill Height (mm)
4100

GÜVENLİK ALANI
Safety Area (mm)
6300x9500

ÜRÜN KODU
Product Code
HNB3301

YAŞ ARALIĞI
Ages
5-12

DÜŞME YÜKSEKLİĞİ
Fall Height (mm)
1500

OTURMA ALANI
Settle Area (mm)
6550x6800

ÜRÜN ADI
Product Name
Bal Topu Serisi

KAPASİTE
Number of User
35

TEPE YÜKSEKLİĞİ
Hill Height (mm)
4100

GÜVENLİK ALANI
Safety Area (mm)
10550x10800

BAL TOPU SERİSİ
Honey Ball Series



HNB3302



BAL TOPU SERİSİ
Honey Ball Series

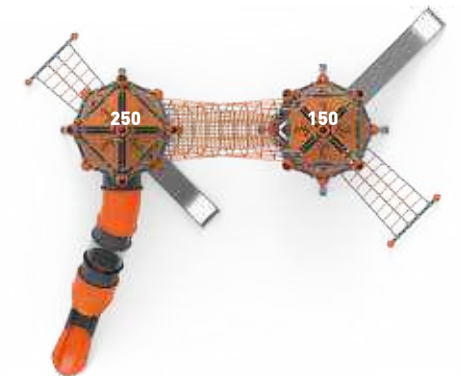

HNB3303

ÜRÜN KODU
Product Code
HNB3302

YAŞ ARALIĞI
Ages
5-12

DÜŞME YÜKSEKLİĞİ
Fall Height (mm)
2500

OTURMA ALANI
Settle Area (mm)
5000x5550

ÜRÜN ADI
Product Name
Bal Topu Serisi

KAPASİTE
Number of User
20

TEPE YÜKSEKLİĞİ
Hill Height (mm)
5100

GÜVENLİK ALANI
Safety Area (mm)
9000x9550

ÜRÜN KODU
Product Code
HNB3303

YAŞ ARALIĞI
Ages
5-12

DÜŞME YÜKSEKLİĞİ
Fall Height (mm)
2500

OTURMA ALANI
Settle Area (mm)
7400x8450

ÜRÜN ADI
Product Name
Bal Topu Serisi

KAPASİTE
Number of User
37

TEPE YÜKSEKLİĞİ
Hill Height (mm)
5100

GÜVENLİK ALANI
Safety Area (mm)
11400x12450

BAL TOPU SERİSİ
Honey Ball Series



HNB3304



BAL TOPU SERİSİ
Honey Ball Series

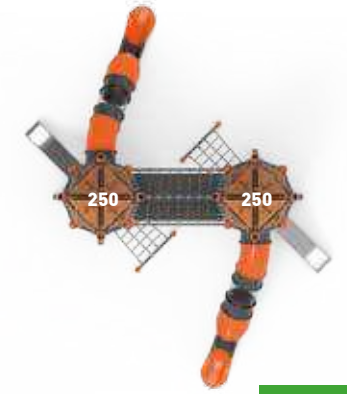

HNB3305

ÜRÜN KODU
Product Code
HNB3304

YAŞ ARALIĞI
Ages
5-12

DÜŞME YÜKSEKLİĞİ
Fall Height (mm)
2500

OTURMA ALANI
Settle Area (mm)
8200x8850

ÜRÜN ADI
Product Name
Bal Topu Serisi

KAPASİTE
Number of User
47

TEPE YÜKSEKLİĞİ
Hill Height (mm)
5100

GÜVENLİK ALANI
Safety Area (mm)
14200x14850

ÜRÜN KODU
Product Code
HNB3305

YAŞ ARALIĞI
Ages
5-12

DÜŞME YÜKSEKLİĞİ
Fall Height (mm)
2500

OTURMA ALANI
Settle Area (mm)
8000x10000

ÜRÜN ADI
Product Name
Bal Topu Serisi

KAPASİTE
Number of User
45

TEPE YÜKSEKLİĞİ
Hill Height (mm)
5100

GÜVENLİK ALANI
Safety Area (mm)
12000x14000



BAMBU EV SERİSİ

Bamboo House Series



BAMBU EV SERİSİ
Bamboo House Series



BH3401

ÜRÜN KODU
Product Code
BH3401

ÜRÜN ADI
Product Name
Bambu Ev Serisi

YAŞ ARALIĞI
Ages
3-12

KAPASİTE
Number of User
16

DÜŞME YÜKSEKLİĞİ
Fall Height (mm)
1000

TEPE YÜKSEKLİĞİ
Hill Height (mm)
4200

OTURMA ALANI
Settle Area (mm)
1400x4400

GÜVENLİK ALANI
Safety Area (mm)
5400x8400

BAMBU EV SERİSİ
Bamboo House Series



BH3402



BAMBU EV SERİSİ
Bamboo House Series



BH3403

ÜRÜN KODU
Product Code
BH3402

YAŞ ARALIĞI
Ages
5-12

DÜŞME YÜKSEKLİĞİ
Fall Height (mm)
1500

OTURMA ALANI
Settle Area (mm)
1400x5900

ÜRÜN ADI
Product Name
Bambu Ev Serisi

KAPASİTE
Number of User
18

TEPE YÜKSEKLİĞİ
Hill Height (mm)
4700

GÜVENLİK ALANI
Safety Area (mm)
5400x9900

ÜRÜN KODU
Product Code
BH3403

YAŞ ARALIĞI
Ages
5-12

DÜŞME YÜKSEKLİĞİ
Fall Height (mm)
1500

OTURMA ALANI
Settle Area (mm)
4400x7000

ÜRÜN ADI
Product Name
Bambu Ev Serisi

KAPASİTE
Number of User
30

TEPE YÜKSEKLİĞİ
Hill Height (mm)
4700

GÜVENLİK ALANI
Safety Area (mm)
8400x11000

BAMBU EV SERİSİ
Bamboo House Series



BH3404



BAMBU EV SERİSİ
Bamboo House Series

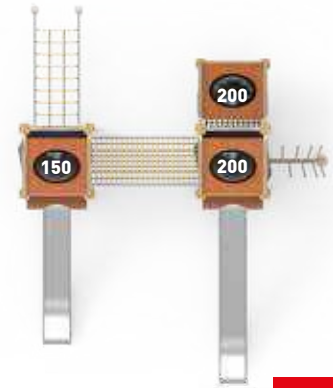

BH3405

ÜRÜN KODU
Product Code
BH3404

YAŞ ARALIĞI
Ages
5-12

DÜŞME YÜKSEKLİĞİ
Fall Height (mm)
1500

OTURMA ALANI
Settle Area (mm)
4700x6200

ÜRÜN ADI
Product Name
Bambu Ev Serisi

KAPASİTE
Number of User
28

TEPE YÜKSEKLİĞİ
Hill Height (mm)
4700

GÜVENLİK ALANI
Safety Area (mm)
8700x10200

ÜRÜN KODU
Product Code
BH3405

YAŞ ARALIĞI
Ages
5-12

DÜŞME YÜKSEKLİĞİ
Fall Height (mm)
2000

OTURMA ALANI
Settle Area (mm)
5600x6600

ÜRÜN ADI
Product Name
Bambu Ev Serisi

KAPASİTE
Number of User
36

TEPE YÜKSEKLİĞİ
Hill Height (mm)
5200

GÜVENLİK ALANI
Safety Area (mm)
9600x10600



BAMBU EV SERİSİ
Bamboo House Series



BH3406

ÜRÜN KODU
Product Code
BH3406

ÜRÜN ADI
Product Name
Bambu Ev Serisi

YAŞ ARALIĞI
Ages
7-14

KAPASİTE
Number of User
48

DÜŞME YÜKSEKLİĞİ
Fall Height (mm)
3000

TEPE YÜKSEKLİĞİ
Hill Height (mm)
6000

OTURMA ALANI
Settle Area (mm)
6000x11650

GÜVENLİK ALANI
Safety Area (mm)
10000x15650



KUŞ YUVASI SERİSİ

Bird Nest Series



KUŞ YUVASI SERİSİ
Bird Nest Series

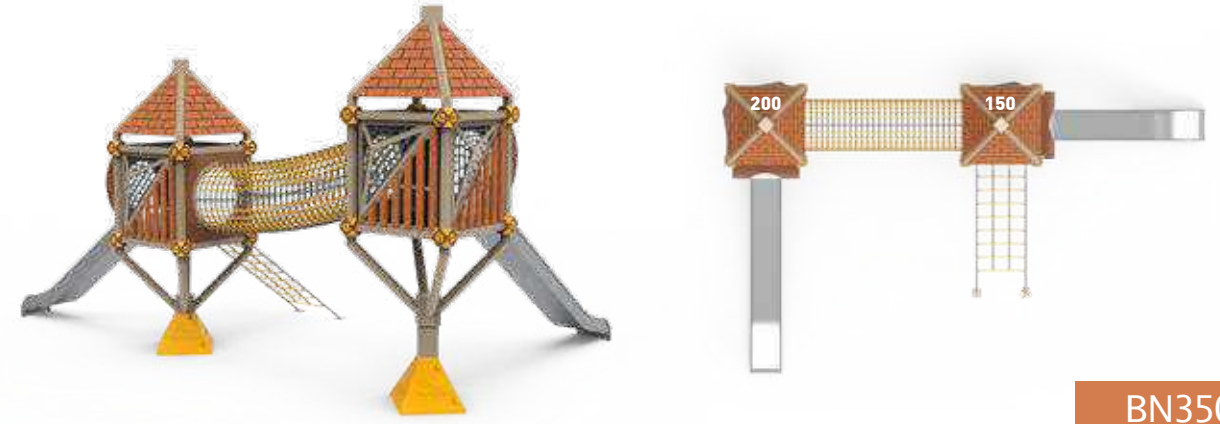

ÜRÜN KODU
Product Code
BN3501

YAŞ ARALIĞI
Ages
5-12

DÜŞME YÜKSEKLİĞİ
Fall Height (mm)
2000

OTURMA ALANI
Settle Area (mm)
4450x7600

ÜRÜN ADI
Product Name
Kuş Yuvası Serisi

KAPASİTE
Number of User
34

TEPE YÜKSEKLİĞİ
Hill Height (mm)
4250

GÜVENLİK ALANI
Safety Area (mm)
8450x11600

BN3501

KUŞ YUVASI SERİSİ
Bird Nest Series

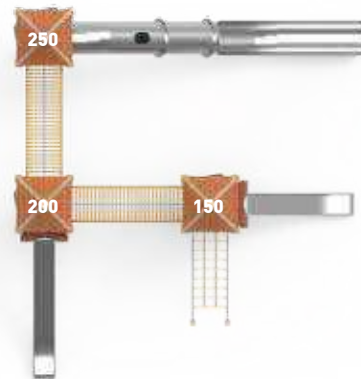

BN3502



KUŞ YUVASI SERİSİ
Bird Nest Series

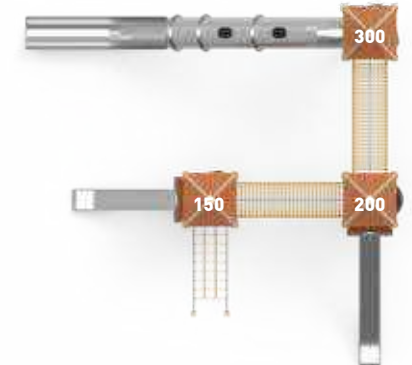

BN3503

ÜRÜN KODU
Product Code
BN3502

YAŞ ARALIĞI
Ages
5-12

DÜŞME YÜKSEKLİĞİ
Fall Height (mm)
2500

OTURMA ALANI
Settle Area (mm)
8100x8300

ÜRÜN ADI
Product Name
Kuş Yuvası Serisi

KAPASİTE
Number of User
58

TEPE YÜKSEKLİĞİ
Hill Height (mm)
5600

GÜVENLİK ALANI
Safety Area (mm)
14100x14300

ÜRÜN KODU
Product Code
BN3503

YAŞ ARALIĞI
Ages
5-12

DÜŞME YÜKSEKLİĞİ
Fall Height (mm)
3000

OTURMA ALANI
Settle Area (mm)
8450x8950

ÜRÜN ADI
Product Name
Kuş Yuvası Serisi

KAPASİTE
Number of User
55

TEPE YÜKSEKLİĞİ
Hill Height (mm)
6100

GÜVENLİK ALANI
Safety Area (mm)
12450x12950

KUŞ YUVASI SERİSİ
Bird Nest Series

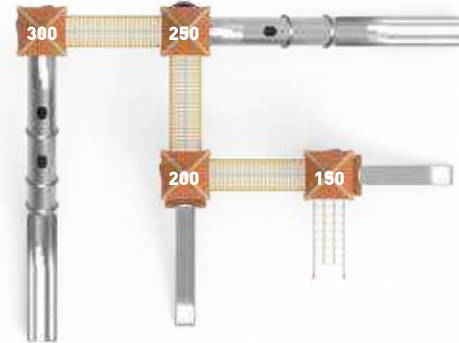

BN3504



KUŞ YUVASI SERİSİ
Bird Nest Series

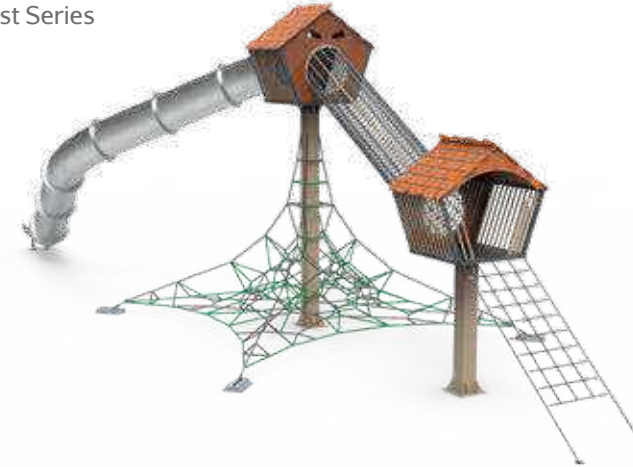

BN3505

ÜRÜN KODU
Product Code
BN3504

YAŞ ARALIĞI
Ages
5-12

DÜŞME YÜKSEKLİĞİ
Fall Height (mm)
3000

OTURMA ALANI
Settle Area (mm)
9000x12000

ÜRÜN ADI
Product Name
Kuş Yuvası Serisi

KAPASİTE
Number of User
74

TEPE YÜKSEKLİĞİ
Hill Height (mm)
6100

GÜVENLİK ALANI
Safety Area (mm)
13000x16000

ÜRÜN KODU
Product Code
BN3505

YAŞ ARALIĞI
Ages
7-14

DÜŞME YÜKSEKLİĞİ
Fall Height (mm)
4000

OTURMA ALANI
Settle Area (mm)
5900x18500

ÜRÜN ADI
Product Name
Kuş Yuvası Serisi

KAPASİTE
Number of User
72

TEPE YÜKSEKLİĞİ
Hill Height (mm)
5700

GÜVENLİK ALANI
Safety Area (mm)
9900x22500



KRİSTAL SERİSİ

Crystal Series



KRİSTAL SERİSİ
Crystal Series

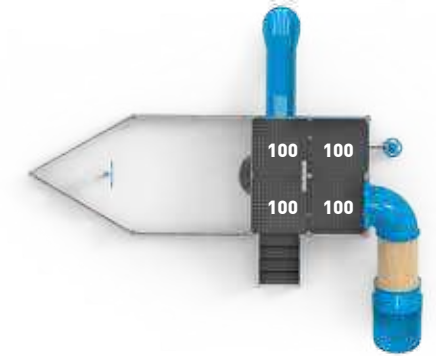

CR601

ÜRÜN KODU
Product Code
CR601

YAŞ ARALIĞI
Ages
3-12

DÜŞME YÜKSEKLİĞİ
Fall Height (mm)
1000

OTURMA ALANI
Settle Area (mm)
6100x7850

ÜRÜN ADI
Product Name
Kristal Serisi

KAPASİTE
Number of User
67

TEPE YÜKSEKLİĞİ
Hill Height (mm)
4320

GÜVENLİK ALANI
Safety Area (mm)
10100x11850

KRİSTAL SERİSİ
Crystal Series



CR602

ÜRÜN KODU
Product Code
CR602

YAŞ ARALIĞI
Ages
3-12

DÜŞME YÜKSEKLİĞİ
Fall Height (mm)
1000

OTURMA ALANI
Settle Area (mm)
4250x5500

ÜRÜN ADI
Product Name
Kristal Serisi

KAPASİTE
Number of User
25

TEPE YÜKSEKLİĞİ
Hill Height (mm)
2250

GÜVENLİK ALANI
Safety Area (mm)
8250x9500



KRİSTAL SERİSİ
Crystal Series

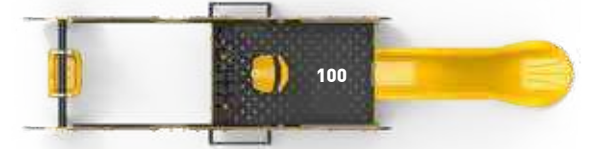

CR603

ÜRÜN KODU
Product Code
CR603

YAŞ ARALIĞI
Ages
3-12

DÜŞME YÜKSEKLİĞİ
Fall Height (mm)
1000

OTURMA ALANI
Settle Area (mm)
1600x6150

ÜRÜN ADI
Product Name
Kristal Serisi

KAPASİTE
Number of User
34

TEPE YÜKSEKLİĞİ
Hill Height (mm)
3330

GÜVENLİK ALANI
Safety Area (mm)
5600x10150

KRİSTAL SERİSİ
Crystal Series



CR604



KRİSTAL SERİSİ
Crystal Series

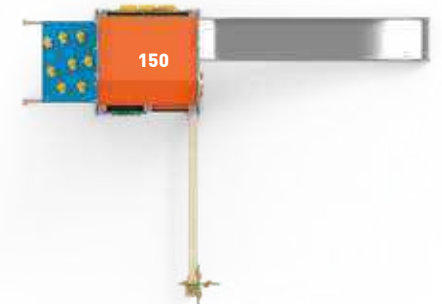

CR608

ÜRÜN KODU
Product Code
CR604

YAŞ ARALIĞI
Ages
5-12

DÜŞME YÜKSEKLİĞİ
Fall Height (mm)
1500

OTURMA ALANI
Settle Area (mm)
6700x6700

ÜRÜN ADI
Product Name
Kristal Serisi

KAPASİTE
Number of User
30

TEPE YÜKSEKLİĞİ
Hill Height (mm)
2700

GÜVENLİK ALANI
Safety Area (mm)
10700x10700

ÜRÜN KODU
Product Code
CR608

YAŞ ARALIĞI
Ages
5-12

DÜŞME YÜKSEKLİĞİ
Fall Height (mm)
1500

OTURMA ALANI
Settle Area (mm)
3500x4500

ÜRÜN ADI
Product Name
Kristal Serisi

KAPASİTE
Number of User
18

TEPE YÜKSEKLİĞİ
Hill Height (mm)
3750

GÜVENLİK ALANI
Safety Area (mm)
7500x8500

KRİSTAL SERİSİ
Crystal Series

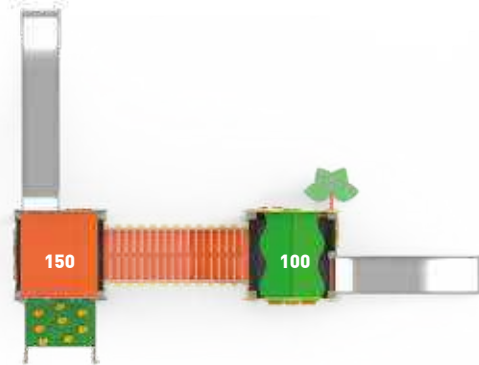

CR609

ÜRÜN KODU
Product Code
CR609

YAŞ ARALIĞI
Ages
5-12

DÜŞME YÜKSEKLİĞİ
Fall Height (mm)
1500

OTURMA ALANI
Settle Area (mm)
4500x6250

ÜRÜN ADI
Product Name
Kristal Serisi

KAPASİTE
Number of User
30

TEPE YÜKSEKLİĞİ
Hill Height (mm)
3750

GÜVENLİK ALANI
Safety Area (mm)
8500x10250



KRİSTAL SERİSİ
Crystal Series



CR610

ÜRÜN KODU
Product Code
CR610

YAŞ ARALIĞI
Ages
5-12

DÜŞME YÜKSEKLİĞİ
Fall Height (mm)
1500

OTURMA ALANI
Settle Area (mm)
4500x6900

ÜRÜN ADI
Product Name
Kristal Serisi

KAPASİTE
Number of User
32

TEPE YÜKSEKLİĞİ
Hill Height (mm)
3800

GÜVENLİK ALANI
Safety Area (mm)
8500x10900



KRİSTAL SERİSİ
Crystal Series



KRİSTAL SERİSİ
Crystal Series



CR611



CR612

ÜRÜN KODU
Product Code
CR611

YAŞ ARALIĞI
Ages
5-12

DÜŞME YÜKSEKLİĞİ
Fall Height (mm)
1500

OTURMA ALANI
Settle Area (mm)
5550x7100

ÜRÜN ADI
Product Name
Kristal Serisi

KAPASİTE
Number of User
40

TEPE YÜKSEKLİĞİ
Hill Height (mm)
3800

GÜVENLİK ALANI
Safety Area (mm)
9550x11100

ÜRÜN KODU
Product Code
CR612

YAŞ ARALIĞI
Ages
5-12

DÜŞME YÜKSEKLİĞİ
Fall Height (mm)
1500

OTURMA ALANI
Settle Area (mm)
4500x9400

ÜRÜN ADI
Product Name
Kristal Serisi

KAPASİTE
Number of User
42

TEPE YÜKSEKLİĞİ
Hill Height (mm)
3800

GÜVENLİK ALANI
Safety Area (mm)
8500x13400

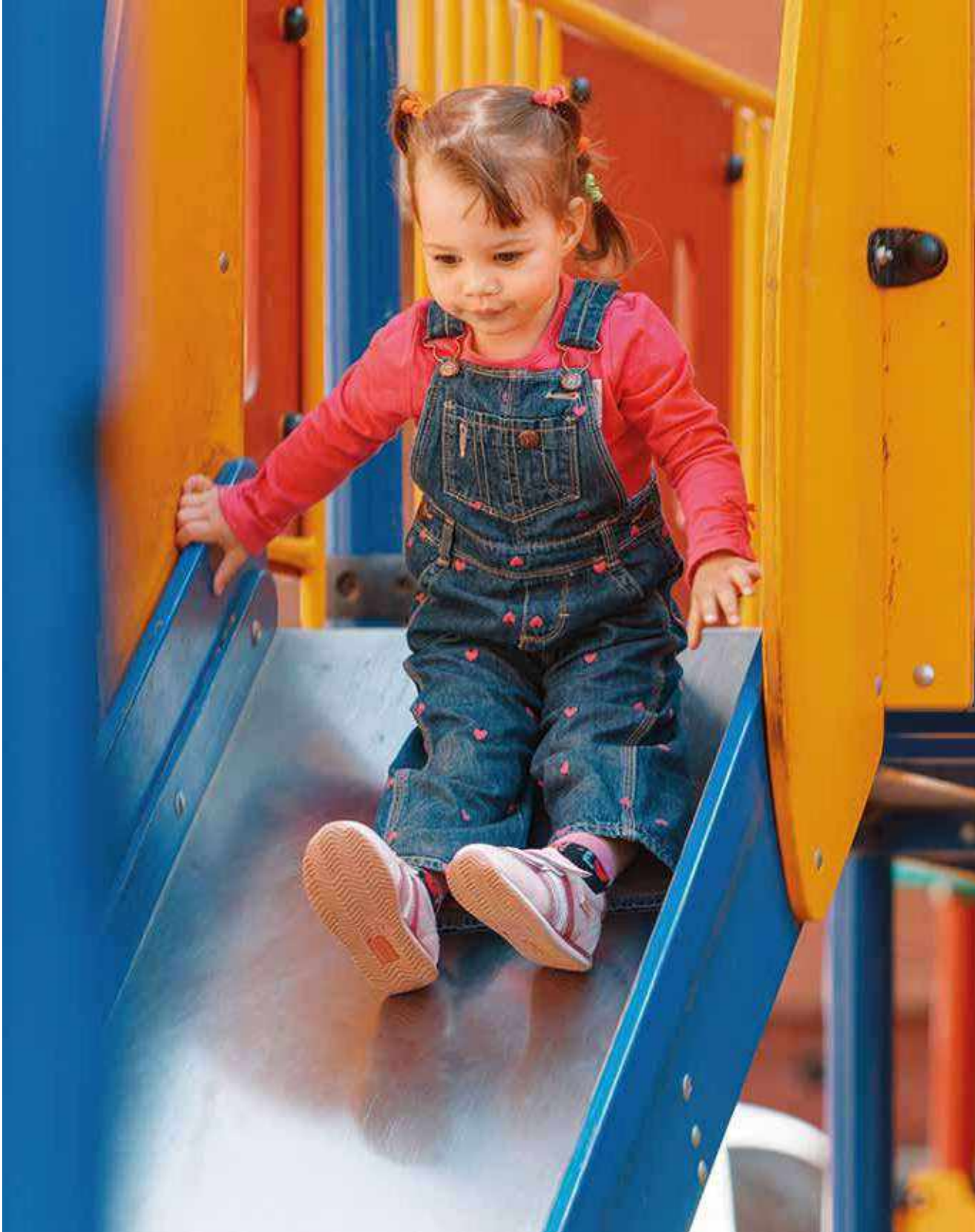

PERİLİ EV SERİSİ

Haunted House Series



PERİLİ EV SERİSİ
Haunted House Series



HH3601

ÜRÜN KODU
Product Code
HH3601

YAŞ ARALIĞI
Ages
3-12

DÜŞME YÜKSEKLİĞİ
Fall Height (mm)
1000

OTURMA ALANI
Settle Area (mm)
5000x5250

ÜRÜN ADI
Product Name
Perili Ev Serisi

KAPASİTE
Number of User
30

TEPE YÜKSEKLİĞİ
Hill Height (mm)
4200

GÜVENLİK ALANI
Safety Area (mm)
9000x9250

PERİLİ EV SERİSİ
Haunted House Series

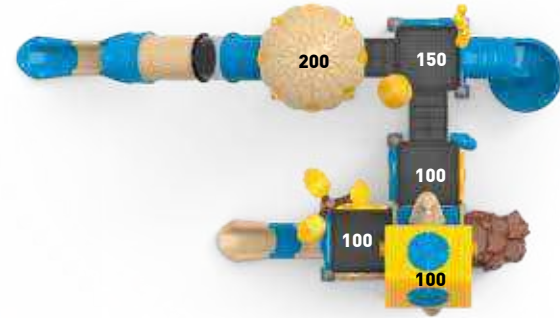

HH3602

ÜRÜN KODU
Product Code
HH3602

YAŞ ARALIĞI
Ages
5-12

DÜŞME YÜKSEKLİĞİ
Fall Height (mm)
2000

OTURMA ALANI
Settle Area (mm)
5400x9400

ÜRÜN ADI
Product Name
Perili Ev Serisi

KAPASİTE
Number of User
47

TEPE YÜKSEKLİĞİ
Hill Height (mm)
5000

GÜVENLİK ALANI
Safety Area (mm)
9400x13400



PERİLİ EV SERİSİ
Haunted House Series

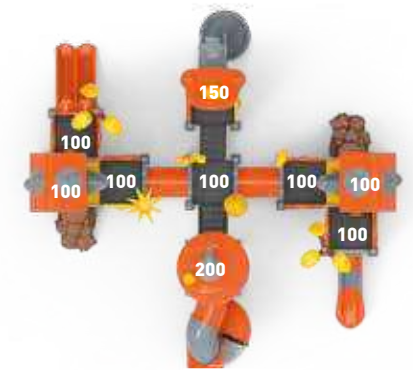

HH3603

ÜRÜN KODU
Product Code
HH3603

YAŞ ARALIĞI
Ages
5-12

DÜŞME YÜKSEKLİĞİ
Fall Height (mm)
2000

OTURMA ALANI
Settle Area (mm)
9250x9500

ÜRÜN ADI
Product Name
Perili Ev Serisi

KAPASİTE
Number of User
78

TEPE YÜKSEKLİĞİ
Hill Height (mm)
5125

GÜVENLİK ALANI
Safety Area (mm)
13250x13500

PERİLİ EV SERİSİ
Haunted House Series



HH3604

ÜRÜN KODU
Product Code
HH3604

YAŞ ARALIĞI
Ages
5-12

DÜŞME YÜKSEKLİĞİ
Fall Height (mm)
2000

OTURMA ALANI
Settle Area (mm)
8850x11800

ÜRÜN ADI
Product Name
Perili Ev Serisi

KAPASİTE
Number of User
76

TEPE YÜKSEKLİĞİ
Hill Height (mm)
4850

GÜVENLİK ALANI
Safety Area (mm)
12850x15800



PERİLİ EV SERİSİ
Haunted House Series

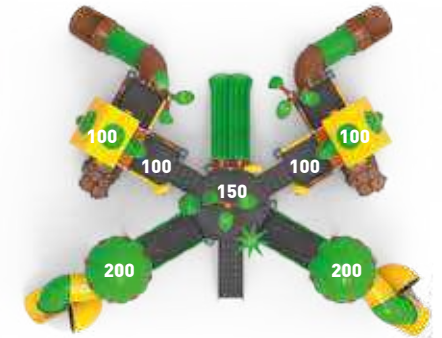

HH3605

ÜRÜN KODU
Product Code
HH3605

YAŞ ARALIĞI
Ages
5-12

DÜŞME YÜKSEKLİĞİ
Fall Height (mm)
2000

OTURMA ALANI
Seating Area (cm)
9100x11200

ÜRÜN ADI
Product Name
Perili Ev Serisi

KAPASİTE
Number of User
84

TEPE YÜKSEKLİĞİ
Hill Height (mm)
4950

GÜVENLİK ALANI
Safety Area (cm)
13100x15200



DİNAMİK SERİSİ
Dynamic Series



DİNAMİK SERİSİ
Dynamic Series



DN301

ÜRÜN KODU
Product Code
DN301

ÜRÜN ADI
Product Name
Dinamik Serisi

YAŞ ARALIĞI
Ages
5-12

KAPASİTE
Number of User
35

DÜŞME YÜKSEKLİĞİ
Fall Height (mm)
2500

TEPE YÜKSEKLİĞİ
Hill Height (mm)
3260

OTURMA ALANI
Settle Area (mm)
7110x7220

GÜVENLİK ALANI
Safety Area (mm)
11110x11220

DİNAMİK SERİSİ
Dynamic Series



DN302

ÜRÜN KODU
Product Code
DN302

YAŞ ARALIĞI
Ages
5-12

DÜŞME YÜKSEKLİĞİ
Fall Height (mm)
2600

OTURMA ALANI
Settle Area (mm)
10800x10660

ÜRÜN ADI
Product Name
Dinamik Serisi

KAPASİTE
Number of User
60

TEPE YÜKSEKLİĞİ
Hill Height (mm)
3200

GÜVENLİK ALANI
Safety Area (mm)
14800x14660



DİNAMİK SERİSİ
Dynamic Series



DN303

ÜRÜN KODU
Product Code
DN303

YAŞ ARALIĞI
Ages
5-12

DÜŞME YÜKSEKLİĞİ
Fall Height (mm)
2600

OTURMA ALANI
Settle Area (mm)
15100x9320

ÜRÜN ADI
Product Name
Dinamik Serisi

KAPASİTE
Number of User
89

TEPE YÜKSEKLİĞİ
Hill Height (mm)
3550

GÜVENLİK ALANI
Safety Area (mm)
19100x13320



DİNAMİK SERİSİ
Dynamic Series



DN304

ÜRÜN KODU
Product Code
DN304

YAŞ ARALIĞI
Ages
5-12

DÜŞME YÜKSEKLİĞİ
Fall Height (mm)
2500

OTURMA ALANI
Settle Area (mm)
17400x10800

ÜRÜN ADI
Product Name
Dinamik Serisi

KAPASİTE
Number of User
101

TEPE YÜKSEKLİĞİ
Hill Height (mm)
3250

GÜVENLİK ALANI
Safety Area (mm)
21400x14800

DİNAMİK SERİSİ
Dynamic Series



DN305



DİNAMİK SERİSİ
Dynamic Series

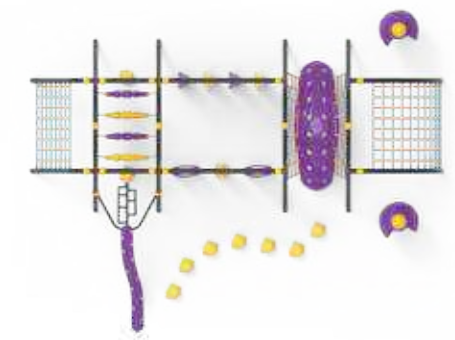

DN306

ÜRÜN KODU
Product Code
DN305

YAŞ ARALIĞI
Ages
5-12

DÜŞME YÜKSEKLİĞİ
Fall Height (mm)
2500

OTURMA ALANI
Settle Area (mm)
12300x10600

ÜRÜN ADI
Product Name
Dinamik Serisi

KAPASİTE
Number of User
36

TEPE YÜKSEKLİĞİ
Hill Height (mm)
4000

GÜVENLİK ALANI
Safety Area (mm)
16300x14600

ÜRÜN KODU
Product Code
DN306

YAŞ ARALIĞI
Ages
5-12

DÜŞME YÜKSEKLİĞİ
Fall Height (mm)
1500

OTURMA ALANI
Settle Area (mm)
7620x9810

ÜRÜN ADI
Product Name
Dinamik Serisi

KAPASİTE
Number of User
53

TEPE YÜKSEKLİĞİ
Hill Height (mm)
2885

GÜVENLİK ALANI
Safety Area (mm)
11620x13810

DİNAMİK SERİSİ
Dynamic Series



DN307

ÜRÜN KODU
Product Code
DN307

YAŞ ARALIĞI
Ages
5-12

DÜŞME YÜKSEKLİĞİ
Fall Height (mm)
1500

OTURMA ALANI
Settle Area (mm)
9650x10360

ÜRÜN ADI
Product Name
Dinamik Serisi

KAPASİTE
Number of User
44

TEPE YÜKSEKLİĞİ
Hill Height (mm)
3070

GÜVENLİK ALANI
Safety Area (mm)
13650x14360



DİNAMİK SERİSİ
Dynamic Series

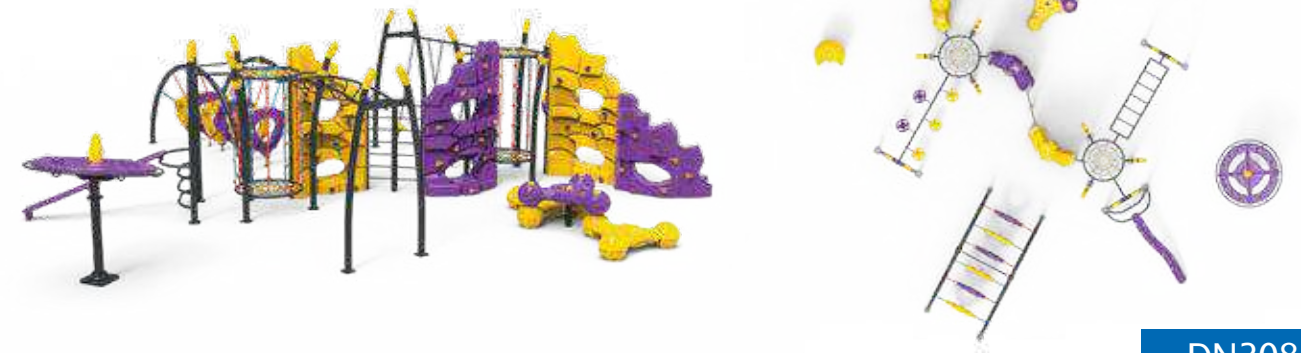

DN308

ÜRÜN KODU
Product Code
DN308

YAŞ ARALIĞI
Ages
5-12

DÜŞME YÜKSEKLİĞİ
Fall Height (mm)
2500

OTURMA ALANI
Settle Area (mm)
13900x12500

ÜRÜN ADI
Product Name
Dinamik Serisi

KAPASİTE
Number of User
84

TEPE YÜKSEKLİĞİ
Hill Height (mm)
3000

GÜVENLİK ALANI
Safety Area (mm)
17900x16500



DİNAMİK SERİSİ
Dynamic Series

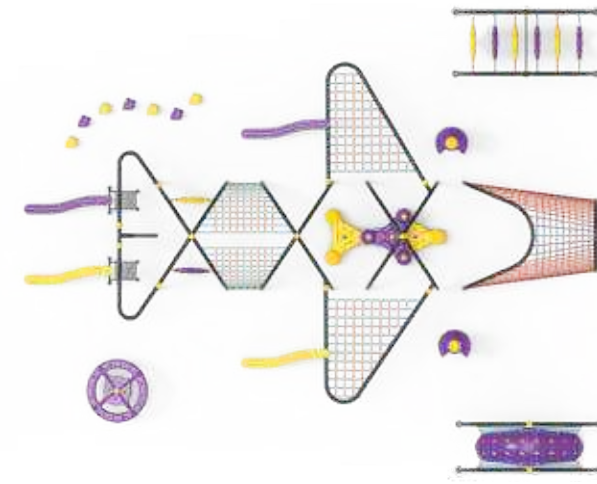

DN309

ÜRÜN KODU
Product Code
DN309

ÜRÜN ADI
Product Name
Dinamik Serisi

YAŞ ARALIĞI
Ages
5-12

KAPASİTE
Number of User
82

DÜŞME YÜKSEKLİĞİ
Fall Height (mm)
1000

TEPE YÜKSEKLİĞİ
Hill Height (mm)
2090

OTURMA ALANI
Settle Area (mm)
13090x16380

GÜVENLİK ALANI
Safety Area (mm)
17090x20380



MERKÜR SERİSİ
Mercury Series

MERKÜR SERİSİ
Mercury Series



MERKÜR SERİSİ
Mercury Series



MR501



MR502

ÜRÜN KODU
Product Code
MR501

YAŞ ARALIĞI
Ages
3-12

DÜŞME YÜKSEKLİĞİ
Fall Height (mm)
2300

OTURMA ALANI
Settle Area (mm)
4660x5390

ÜRÜN ADI
Product Name
Merkür Serisi

KAPASİTE
Number of User
32

TEPE YÜKSEKLİĞİ
Hill Height (mm)
2300

GÜVENLİK ALANI
Safety Area (mm)
8660x9390

ÜRÜN KODU
Product Code
MR502

YAŞ ARALIĞI
Ages
5-12

DÜŞME YÜKSEKLİĞİ
Fall Height (mm)
2300

OTURMA ALANI
Settle Area (mm)
12040x7420

ÜRÜN ADI
Product Name
Merkür Serisi

KAPASİTE
Number of User
53

TEPE YÜKSEKLİĞİ
Hill Height (mm)
3400

GÜVENLİK ALANI
Safety Area (mm)
16040x11420

MERKÜR SERİSİ
Mercury Series



MR502-1



MERKÜR SERİSİ
Mercury Series

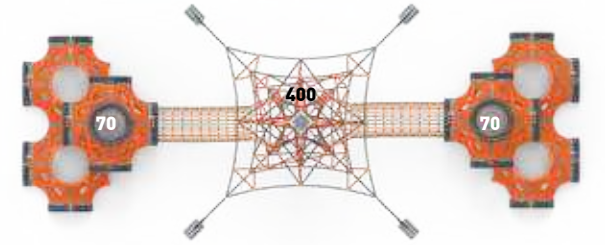

MR503

ÜRÜN KODU
Product Code
MR502-1

YAŞ ARALIĞI
Ages
5-12

DÜŞME YÜKSEKLİĞİ
Fall Height (mm)
2300

OTURMA ALANI
Settle Area (mm)
6450x8350

ÜRÜN ADI
Product Name
Merkür Serisi

KAPASİTE
Number of User
20

TEPE YÜKSEKLİĞİ
Hill Height (mm)
3400

GÜVENLİK ALANI
Safety Area (mm)
10450x12350

ÜRÜN KODU
Product Code
MR503

YAŞ ARALIĞI
Ages
5-12

DÜŞME YÜKSEKLİĞİ
Fall Height (mm)
2300

OTURMA ALANI
Settle Area (mm)
14785x5900

ÜRÜN ADI
Product Name
Merkür Serisi

KAPASİTE
Number of User
60

TEPE YÜKSEKLİĞİ
Hill Height (mm)
4000

GÜVENLİK ALANI
Safety Area (mm)
18785x9900



AĞAÇ SERİSİ

Tree Series



AĞAÇ SERİSİ
Tree Series



TR401

ÜRÜN KODU
Product Code
TR401

ÜRÜN ADI
Product Name
Ağaç Serisi

YAŞ ARALIĞI
Ages
3-12

KAPASİTE
Number of User
17

DÜŞME YÜKSEKLİĞİ
Fall Height (mm)
1000

TEPE YÜKSEKLİĞİ
Hill Height (mm)
4000

OTURMA ALANI
Settle Area (mm)
5600x5000

GÜVENLİK ALANI
Safety Area (mm)
9600x9000

AĞAÇ SERİSİ
Tree Series



AĞAÇ SERİSİ
Tree Series



TR402

TR403

ÜRÜN KODU
Product Code
TR402

YAŞ ARALIĞI
Ages
5-12

DÜŞME YÜKSEKLİĞİ
Fall Height (mm)
1500

OTURMA ALANI
Settle Area (mm)
5700x5400

ÜRÜN ADI
Product Name
Ağaç Serisi

KAPASİTE
Number of User
14

TEPE YÜKSEKLİĞİ
Hill Height (mm)
4500

GÜVENLİK ALANI
Safety Area (mm)
9700x9400

ÜRÜN KODU
Product Code
TR403

YAŞ ARALIĞI
Ages
5-12

DÜŞME YÜKSEKLİĞİ
Fall Height (mm)
2000

OTURMA ALANI
Settle Area (mm)
6200x5200

ÜRÜN ADI
Product Name
Ağaç Serisi

KAPASİTE
Number of User
22

TEPE YÜKSEKLİĞİ
Hill Height (mm)
5000

GÜVENLİK ALANI
Safety Area (mm)
10200x9200

AĞAÇ SERİSİ
Tree Series



TR404

ÜRÜN KODU
Product Code
TR404

YAŞ ARALIĞI
Ages
5-12

DÜŞME YÜKSEKLİĞİ
Fall Height (mm)
1500

OTURMA ALANI
Settle Area (mm)
6000x7100

ÜRÜN ADI
Product Name
Ağaç Serisi

KAPASİTE
Number of User
31

TEPE YÜKSEKLİĞİ
Hill Height (mm)
4000

GÜVENLİK ALANI
Safety Area (mm)
10000x10100



AĞAÇ SERİSİ
Tree Series



TR405

ÜRÜN KODU
Product Code
TR405

YAŞ ARALIĞI
Ages
5-12

DÜŞME YÜKSEKLİĞİ
Fall Height (mm)
1500

OTURMA ALANI
Settle Area (mm)
9900x6865

ÜRÜN ADI
Product Name
Ağaç Serisi

KAPASİTE
Number of User
40

TEPE YÜKSEKLİĞİ
Hill Height (mm)
5000

GÜVENLİK ALANI
Safety Area (mm)
13900x10865



AĞAÇ SERİSİ Tree Series

TR406

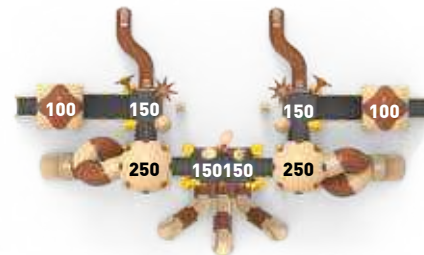

ÜRÜN KODU
Product Code
TR406

ÜRÜN ADI
Product Name
Ağaç Serisi

YAŞ ARALIĞI
Ages
5-12

KAPASİTE
Number of User
88

DÜŞME YÜKSEKLİĞİ
Fall Height (mm)
2500

TEPE YÜKSEKLİĞİ
Hill Height (mm)
5500

OTURMA ALANI
Settle Area (mm)
14350x8550

GÜVENLİK ALANI
Safety Area (mm)
18350x12550

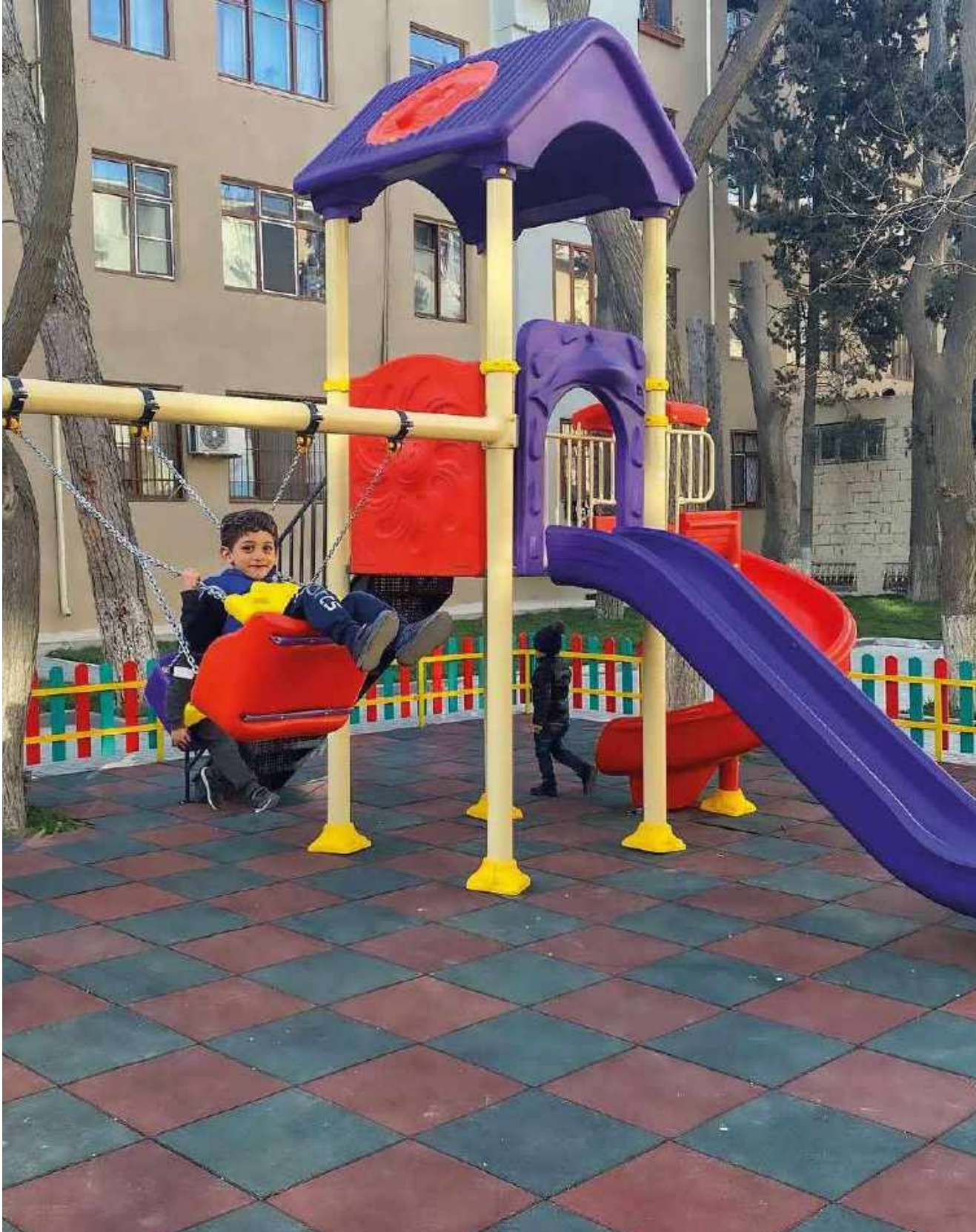

BADEM SERİSİ

Almond Series



BADEM SERİSİ
Almond Series



ÜRÜN KODU
Product Code
BD701

YAŞ ARALIĞI
Ages
5-12

DÜŞME YÜKSEKLİĞİ
Fall Height (mm)
1500

OTURMA ALANI
Settle Area (mm)
5430x6000

ÜRÜN ADI
Product Name
Badem Serisi

KAPASİTE
Number of User
16

TEPE YÜKSEKLİĞİ
Hill Height (mm)
3810

GÜVENLİK ALANI
Safety Area (mm)
9430x10000

BD701

BADEM SERİSİ
Almond Series



BD701-1



BD701-2



BADEM SERİSİ
Almond Series



ÜRÜN KODU
Product Code
BD701-1

YAŞ ARALIĞI
Ages
5-12

DÜŞME YÜKSEKLİĞİ
Fall Height (mm)
1500

OTURMA ALANI
Settle Area (mm)
3040x5430

ÜRÜN ADI
Product Name
Badem Serisi

KAPASİTE
Number of User
12

TEPE YÜKSEKLİĞİ
Hill Height (mm)
3810

GÜVENLİK ALANI
Safety Area (mm)
7040x9430

ÜRÜN KODU
Product Code
BD701-2

YAŞ ARALIĞI
Ages
5-12

DÜŞME YÜKSEKLİĞİ
Fall Height (mm)
1500

OTURMA ALANI
Settle Area (mm)
4390x5430

ÜRÜN ADI
Product Name
Badem Serisi

KAPASİTE
Number of User
12

TEPE YÜKSEKLİĞİ
Hill Height (mm)
3810

GÜVENLİK ALANI
Safety Area (mm)
8390x9430

BADEM SERİSİ
Almond Series



BD702



BADEM SERİSİ
Almond Series

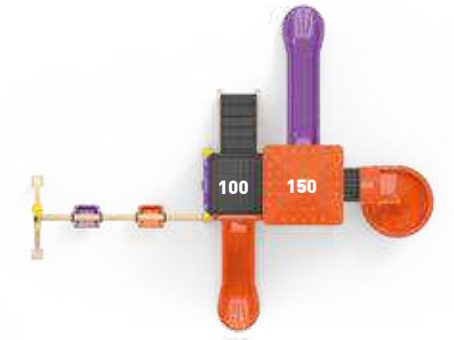

BD703

ÜRÜN KODU
Product Code
BD702

YAŞ ARALIĞI
Ages
5-12

DÜŞME YÜKSEKLİĞİ
Fall Height (mm)
1500

OTURMA ALANI
Settle Area (mm)
4890x4975

ÜRÜN ADI
Product Name
Badem Serisi

KAPASİTE
Number of User
20

TEPE YÜKSEKLİĞİ
Hill Height (mm)
3825

GÜVENLİK ALANI
Safety Area (mm)
8890x8975

ÜRÜN KODU
Product Code
BD703

YAŞ ARALIĞI
Ages
5-12

DÜŞME YÜKSEKLİĞİ
Fall Height (mm)
1500

OTURMA ALANI
Settle Area (mm)
5790x7150

ÜRÜN ADI
Product Name
Badem Serisi

KAPASİTE
Number of User
20

TEPE YÜKSEKLİĞİ
Hill Height (mm)
3810

GÜVENLİK ALANI
Safety Area (mm)
9790x11150

BADEM SERİSİ
Almond Series



BADEM SERİSİ
Almond Series

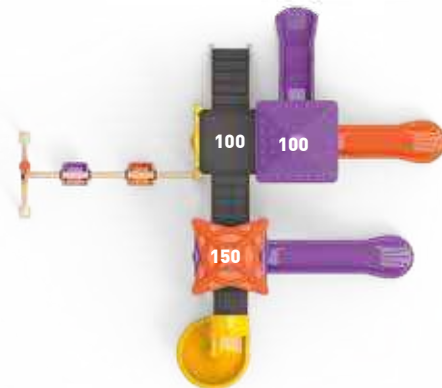

BD704



BD705

ÜRÜN KODU
Product Code
BD704

YAŞ ARALIĞI
Ages
5-12

DÜŞME YÜKSEKLİĞİ
Fall Height (mm)
1500

OTURMA ALANI
Settle Area (mm)
6660x7430

ÜRÜN ADI
Product Name
Badem Serisi

KAPASİTE
Number of User
29

TEPE YÜKSEKLİĞİ
Hill Height (mm)
3825

GÜVENLİK ALANI
Safety Area (mm)
10660x11430

ÜRÜN KODU
Product Code
BD705

YAŞ ARALIĞI
Ages
5-12

DÜŞME YÜKSEKLİĞİ
Fall Height (mm)
2000

OTURMA ALANI
Settle Area (mm)
5190x5925

ÜRÜN ADI
Product Name
Badem Serisi

KAPASİTE
Number of User
22

TEPE YÜKSEKLİĞİ
Hill Height (mm)
4325

GÜVENLİK ALANI
Safety Area (mm)
9190x9925

BADEM SERİSİ
Almond Series

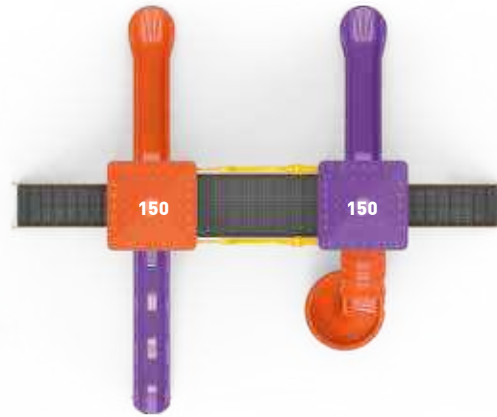

BD706

ÜRÜN KODU
Product Code
BD706

YAŞ ARALIĞI
Ages
5-12

DÜŞME YÜKSEKLİĞİ
Fall Height (mm)
1500

OTURMA ALANI
Settle Area (mm)
6520x7860

ÜRÜN ADI
Product Name
Badem Serisi

KAPASİTE
Number of User
32

TEPE YÜKSEKLİĞİ
Hill Height (mm)
3840

GÜVENLİK ALANI
Safety Area (mm)
10520x11860



BADEM SERİSİ
Almond Series



BD707

ÜRÜN KODU
Product Code
BD707

YAŞ ARALIĞI
Ages
5-12

DÜŞME YÜKSEKLİĞİ
Fall Height (mm)
2000

OTURMA ALANI
Settle Area (mm)
6490x6620

ÜRÜN ADI
Product Name
Badem Serisi

KAPASİTE
Number of User
43

TEPE YÜKSEKLİĞİ
Hill Height (mm)
4310

GÜVENLİK ALANI
Safety Area (mm)
10490x10620

BADEM SERİSİ
Almond Series



BADEM SERİSİ
Almond Series



BD708

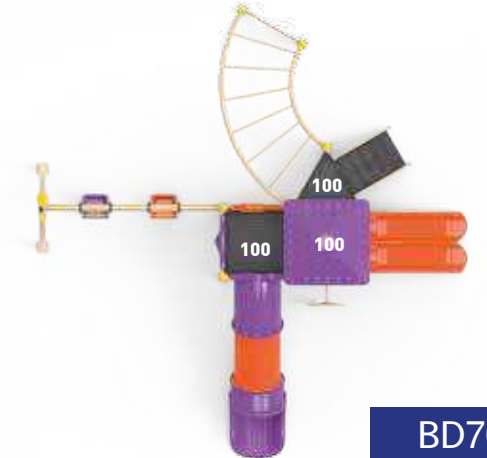

BD709

ÜRÜN KODU
Product Code
BD708

YAŞ ARALIĞI
Ages
5-12

DÜŞME YÜKSEKLİĞİ
Fall Height (mm)
2000

OTURMA ALANI
Settle Area (mm)
4500x7550

ÜRÜN ADI
Product Name
Badem Serisi

KAPASİTE
Number of User
22

TEPE YÜKSEKLİĞİ
Hill Height (mm)
4300

GÜVENLİK ALANI
Safety Area (mm)
8500x11550

ÜRÜN KODU
Product Code
BD709

YAŞ ARALIĞI
Ages
5-12

DÜŞME YÜKSEKLİĞİ
Fall Height (mm)
1000

OTURMA ALANI
Settle Area (mm)
7200x7650

ÜRÜN ADI
Product Name
Badem Serisi

KAPASİTE
Number of User
30

TEPE YÜKSEKLİĞİ
Hill Height (mm)
3300

GÜVENLİK ALANI
Safety Area (mm)
11200x11650

BADEM SERİSİ
Almond Series



BD710

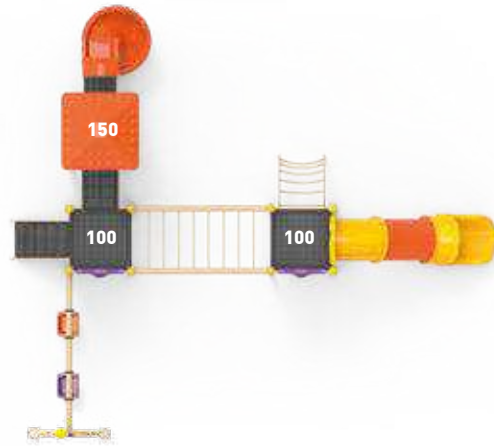

BADEM SERİSİ
Almond Series



BD711

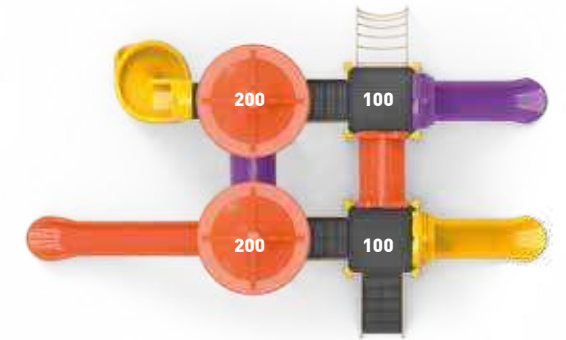

ÜRÜN KODU
Product Code
BD710

YAŞ ARALIĞI
Ages
5-12

DÜŞME YÜKSEKLİĞİ
Fall Height (mm)
1500

OTURMA ALANI
Settle Area (mm)
8100x8950

ÜRÜN ADI
Product Name
Badem Serisi

KAPASİTE
Number of User
34

TEPE YÜKSEKLİĞİ
Hill Height (mm)
3800

GÜVENLİK ALANI
Safety Area (mm)
12100x12950

ÜRÜN KODU
Product Code
BD711

YAŞ ARALIĞI
Ages
5-12

DÜŞME YÜKSEKLİĞİ
Fall Height (mm)
2000

OTURMA ALANI
Settle Area (mm)
5600x8700

ÜRÜN ADI
Product Name
Badem Serisi

KAPASİTE
Number of User
37

TEPE YÜKSEKLİĞİ
Hill Height (mm)
4800

GÜVENLİK ALANI
Safety Area (mm)
9600x12700

BADEM SERİSİ
Almond Series

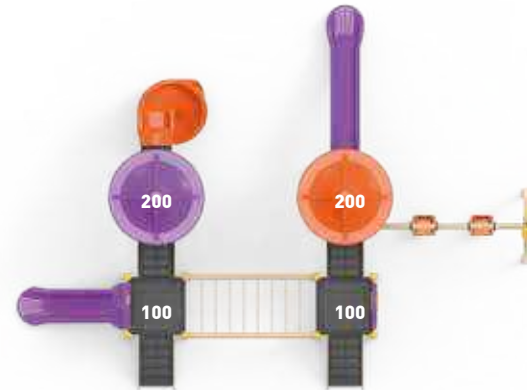

BD712



BADEM SERİSİ
Almond Series

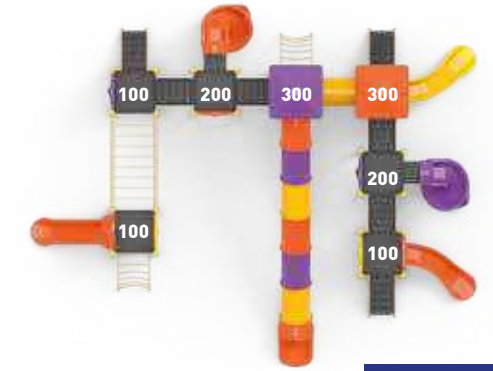

BD713

ÜRÜN KODU
Product Code
BD712

YAŞ ARALIĞI
Ages
5-12

DÜŞME YÜKSEKLİĞİ
Fall Height (mm)
2000

OTURMA ALANI
Settle Area (mm)
7600x9850

ÜRÜN ADI
Product Name
Badem Serisi

KAPASİTE
Number of User
46

TEPE YÜKSEKLİĞİ
Hill Height (mm)
4800

GÜVENLİK ALANI
Safety Area (mm)
11600x13850

ÜRÜN KODU
Product Code
BD713

YAŞ ARALIĞI
Ages
5-12

DÜŞME YÜKSEKLİĞİ
Fall Height (mm)
3000

OTURMA ALANI
Settle Area (mm)
9600x11850

ÜRÜN ADI
Product Name
Badem Serisi

KAPASİTE
Number of User
90

TEPE YÜKSEKLİĞİ
Hill Height (mm)
5300

GÜVENLİK ALANI
Safety Area (mm)
13600x15850



GÖKKUŞAĞI SERİSİ

Rainbow Series



GÖKKUŞAĞI SERİSİ

Rainbow Series

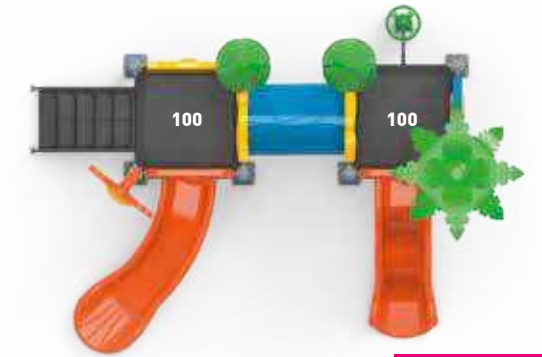

GK3701

ÜRÜN KODU
Product Code
GK3701

ÜRÜN ADI
Product Name
Gökkuşığı Serisi

YAŞ ARALIĞI
Ages
3-12

KAPASİTE
Number of User
18

DÜŞME YÜKSEKLİĞİ
Fall Height (mm)
1000

TEPE YÜKSEKLİĞİ
Hill Height (mm)
3580

OTURMA ALANI
Settle Area (mm)
3700x5040

GÜVENLİK ALANI
Safety Area (mm)
7700x9040

GÖKKUŞAĞI SERİSİ
Rainbow Series

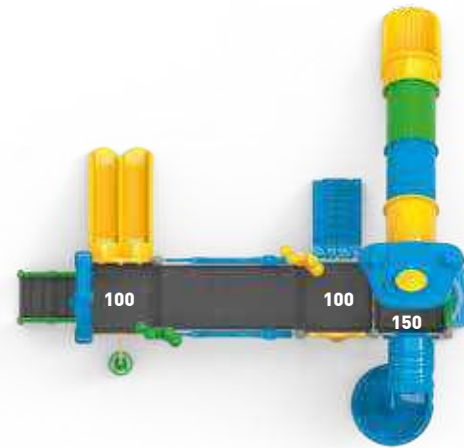

GK3702

ÜRÜN KODU
Product Code
GK3702

YAŞ ARALIĞI
Ages
5-12

DÜŞME YÜKSEKLİĞİ
Fall Height (mm)
1500

OTURMA ALANI
Settle Area (mm)
6840x7020

ÜRÜN ADI
Product Name
Gökkuşağı Serisi

KAPASİTE
Number of User
36

TEPE YÜKSEKLİĞİ
Hill Height (mm)
4330

GÜVENLİK ALANI
Safety Area (mm)
10840x11020



GÖKKUŞAĞI SERİSİ
Rainbow Series

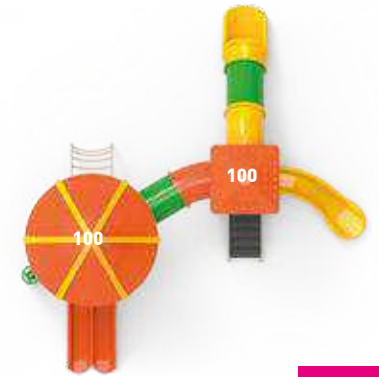

GK3703

ÜRÜN KODU
Product Code
GK3703

YAŞ ARALIĞI
Ages
3-12

DÜŞME YÜKSEKLİĞİ
Fall Height (mm)
1000

OTURMA ALANI
Settle Area (mm)
7130x7610

ÜRÜN ADI
Product Name
Gökkuşağı Serisi

KAPASİTE
Number of User
28

TEPE YÜKSEKLİĞİ
Hill Height (mm)
4940

GÜVENLİK ALANI
Safety Area (mm)
11130x11610

GÖKKUŞAĞI SERİSİ
Rainbow Series



GK3704

ÜRÜN KODU
Product Code
GK3704

YAŞ ARALIĞI
Ages
5-12

DÜŞME YÜKSEKLİĞİ
Fall Height (mm)
1500

OTURMA ALANI
Settle Area (mm)
7450x8865

ÜRÜN ADI
Product Name
Gökkuşuğu Serisi

KAPASİTE
Number of User
34

TEPE YÜKSEKLİĞİ
Hill Height (mm)
4000

GÜVENLİK ALANI
Safety Area (mm)
11450x12865



GÖKKUŞAĞI SERİSİ
Rainbow Series

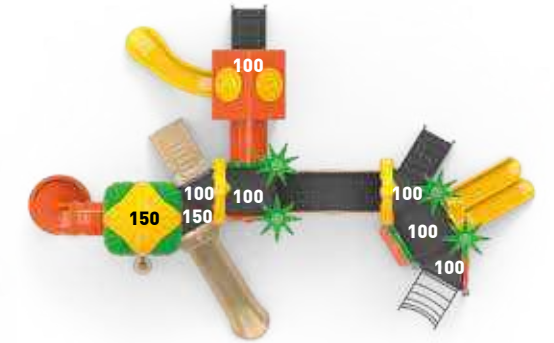

GK3705

ÜRÜN KODU
Product Code
GK3705

YAŞ ARALIĞI
Ages
5-12

DÜŞME YÜKSEKLİĞİ
Fall Height (mm)
1500

OTURMA ALANI
Settle Area (mm)
7150x10250

ÜRÜN ADI
Product Name
Gökkuşuğu Serisi

KAPASİTE
Number of User
65

TEPE YÜKSEKLİĞİ
Hill Height (mm)
4200

GÜVENLİK ALANI
Safety Area (mm)
11150x14250

GÖKKUŞAĞI SERİSİ
Rainbow Series

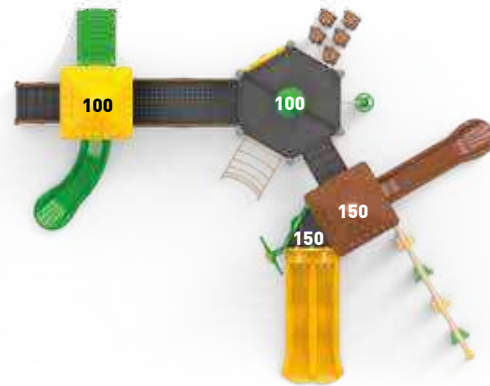

GK3706

ÜRÜN KODU
Product Code
GK3706

YAŞ ARALIĞI
Ages
5-12

DÜŞME YÜKSEKLİĞİ
Fall Height (mm)
1500

OTURMA ALANI
Settle Area (mm)
7370x9450

ÜRÜN ADI
Product Name
Gökkuşuğu Serisi

KAPASİTE
Number of User
62

TEPE YÜKSEKLİĞİ
Hill Height (mm)
3900

GÜVENLİK ALANI
Safety Area (mm)
11370x13450



GÖKKUŞAĞI SERİSİ
Rainbow Series

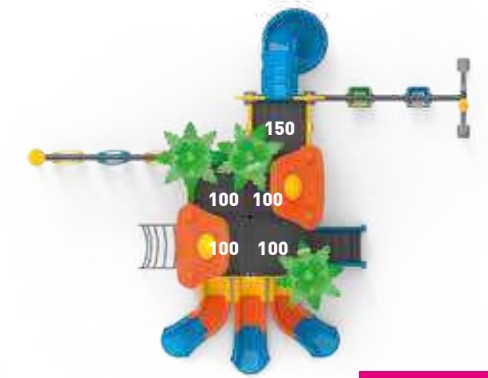

GK3707

ÜRÜN KODU
Product Code
GK3707

YAŞ ARALIĞI
Ages
5-12

DÜŞME YÜKSEKLİĞİ
Fall Height (mm)
1500

OTURMA ALANI
Settle Area (mm)
7120x8580

ÜRÜN ADI
Product Name
Gökkuşuğu Serisi

KAPASİTE
Number of User
46

TEPE YÜKSEKLİĞİ
Hill Height (mm)
4340

GÜVENLİK ALANI
Safety Area (mm)
11120x12580

GÖKKUŞAĞI SERİSİ
Rainbow Series



GK3708

ÜRÜN KODU
Product Code
GK3708

YAŞ ARALIĞI
Ages
5-12

DÜŞME YÜKSEKLİĞİ
Fall Height (mm)
3000

OTURMA ALANI
Settle Area (mm)
6980x10770

ÜRÜN ADI
Product Name
Gökkuşığı Serisi

KAPASİTE
Number of User
46

TEPE YÜKSEKLİĞİ
Hill Height (mm)
6120

GÜVENLİK ALANI
Safety Area (mm)
10980x14770



GÖKKUŞAĞI SERİSİ
Rainbow Series

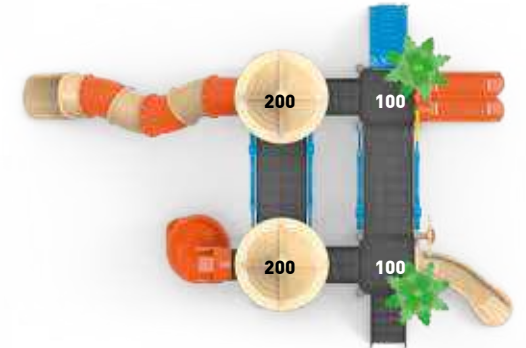

GK3709

ÜRÜN KODU
Product Code
GK3709

YAŞ ARALIĞI
Ages
5-12

DÜŞME YÜKSEKLİĞİ
Fall Height (mm)
2000

OTURMA ALANI
Settle Area (mm)
6900x9850

ÜRÜN ADI
Product Name
Gökkuşığı Serisi

KAPASİTE
Number of User
55

TEPE YÜKSEKLİĞİ
Hill Height (mm)
4800

GÜVENLİK ALANI
Safety Area (mm)
10900x13850

GÖKKUŞAĞI SERİSİ
Rainbow Series



GK3710

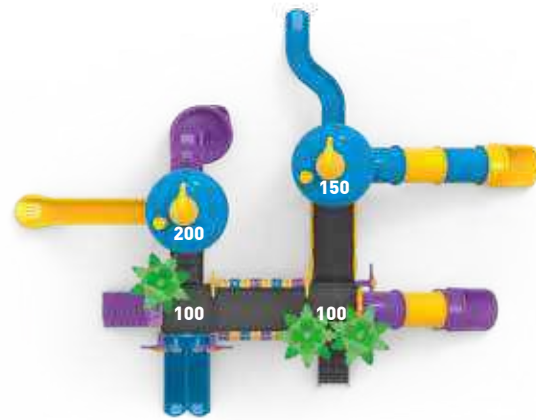

GÖKKUŞAĞI SERİSİ
Rainbow Series

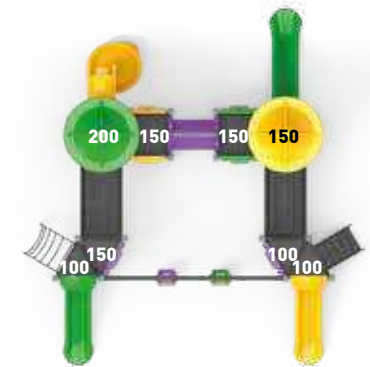

GK3711

ÜRÜN KODU
Product Code
GK3710

YAŞ ARALIĞI
Ages
5-12

DÜŞME YÜKSEKLİĞİ
Fall Height (mm)
2000

OTURMA ALANI
Settle Area (mm)
8400x11520

ÜRÜN ADI
Product Name
Gökkuşığı Serisi

KAPASİTE
Number of User
50

TEPE YÜKSEKLİĞİ
Hill Height (mm)
5180

GÜVENLİK ALANI
Safety Area (mm)
12400x15520

ÜRÜN KODU
Product Code
GK3711

YAŞ ARALIĞI
Ages
5-12

DÜŞME YÜKSEKLİĞİ
Fall Height (mm)
2000

OTURMA ALANI
Settle Area (mm)
8570x8920

ÜRÜN ADI
Product Name
Gökkuşığı Serisi

KAPASİTE
Number of User
50

TEPE YÜKSEKLİĞİ
Hill Height (mm)
4800

GÜVENLİK ALANI
Safety Area (mm)
12570x12920

GÖKKUŞAĞI SERİSİ
Rainbow Series

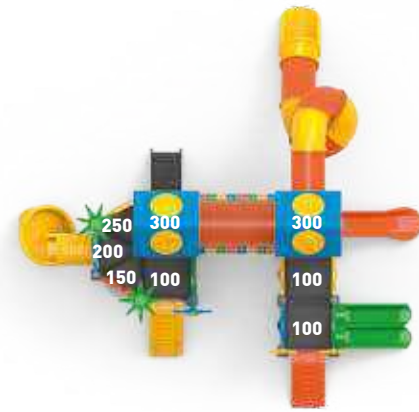

GK3712

ÜRÜN KODU
Product Code
GK3712

YAŞ ARALIĞI
Ages
5-12

DÜŞME YÜKSEKLİĞİ
Fall Height (mm)
3000

OTURMA ALANI
Settle Area (mm)
9080x9360

ÜRÜN ADI
Product Name
Gökkuşağı Serisi

KAPASİTE
Number of User
84

TEPE YÜKSEKLİĞİ
Hill Height (mm)
5530

GÜVENLİK ALANI
Safety Area (mm)
13080x13360



GÖKKUŞAĞI SERİSİ
Rainbow Series

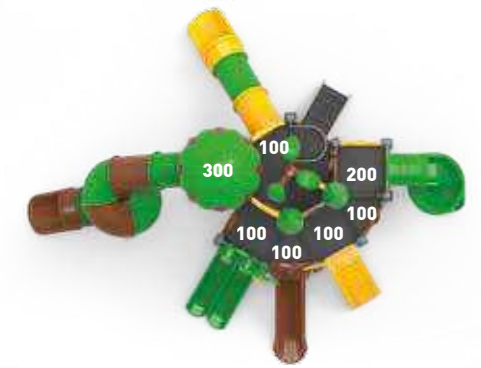

GK3713

ÜRÜN KODU
Product Code
GK3713

YAŞ ARALIĞI
Ages
5-12

DÜŞME YÜKSEKLİĞİ
Fall Height (mm)
3000

OTURMA ALANI
Settle Area (mm)
7910x9750

ÜRÜN ADI
Product Name
Gökkuşağı Serisi

KAPASİTE
Number of User
54

TEPE YÜKSEKLİĞİ
Hill Height (mm)
5960

GÜVENLİK ALANI
Safety Area (mm)
11910x13750

GÖKKUŞAĞI SERİSİ
Rainbow Series



GK3714

ÜRÜN KODU
Product Code
GK3714

YAŞ ARALIĞI
Ages
5-12

DÜŞME YÜKSEKLİĞİ
Fall Height (mm)
2750

OTURMA ALANI
Settle Area (mm)
5420x10350

ÜRÜN ADI
Product Name
Gökkuşağı Serisi

KAPASİTE
Number of User
74

TEPE YÜKSEKLİĞİ
Hill Height (mm)
5700

GÜVENLİK ALANI
Safety Area (mm)
9420x14350



GÖKKUŞAĞI SERİSİ
Rainbow Series



GK3715

ÜRÜN KODU
Product Code
GK3715

YAŞ ARALIĞI
Ages
5-12

DÜŞME YÜKSEKLİĞİ
Fall Height (mm)
2000

OTURMA ALANI
Settle Area (mm)
6750x10000

ÜRÜN ADI
Product Name
Gökkuşağı Serisi

KAPASİTE
Number of User
60

TEPE YÜKSEKLİĞİ
Hill Height (mm)
5380

GÜVENLİK ALANI
Safety Area (mm)
10750x14000

GÖKKUŞAĞI SERİSİ
Rainbow Series

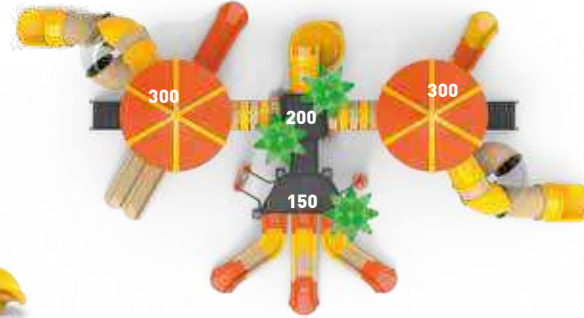

GK3716

ÜRÜN KODU
Product Code
GK3716

YAŞ ARALIĞI
Ages
5-12

DÜŞME YÜKSEKLİĞİ
Fall Height (mm)
3000

OTURMA ALANI
Settle Area (mm)
7700x14120

ÜRÜN ADI
Product Name
Gökkuşığı Serisi

KAPASİTE
Number of User
82

TEPE YÜKSEKLİĞİ
Hill Height (mm)
6940

GÜVENLİK ALANI
Safety Area (mm)
11700x18120



GÖKKUŞAĞI SERİSİ
Rainbow Series

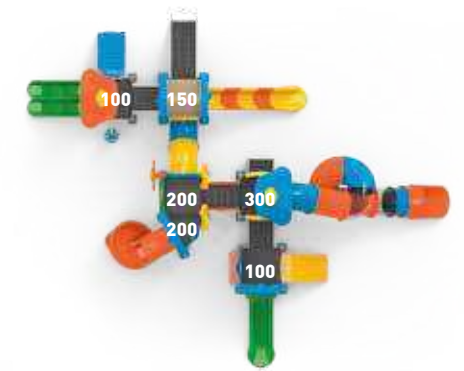

GK3717

ÜRÜN KODU
Product Code
GK3717

YAŞ ARALIĞI
Ages
5-12

DÜŞME YÜKSEKLİĞİ
Fall Height (mm)
3000

OTURMA ALANI
Settle Area (mm)
9690x11690

ÜRÜN ADI
Product Name
Gökkuşığı Serisi

KAPASİTE
Number of User
62

TEPE YÜKSEKLİĞİ
Hill Height (mm)
6410

GÜVENLİK ALANI
Safety Area (mm)
13690x15690

GÖKKUŞAĞI SERİSİ
Rainbow Series

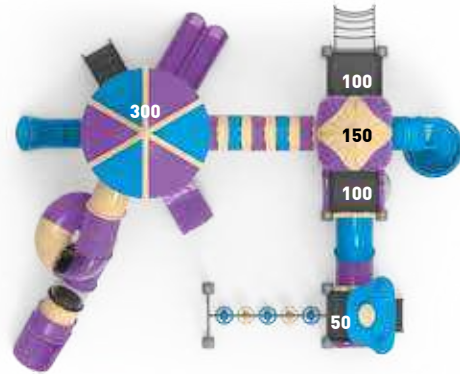

GK3718



GÖKKUŞAĞI SERİSİ
Rainbow Series

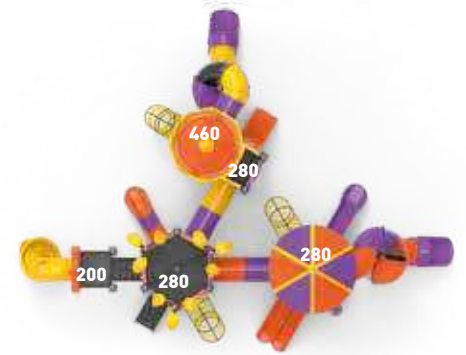

GK3719

ÜRÜN KODU
Product Code
GK3718

YAŞ ARALIĞI
Ages
5-12

DÜŞME YÜKSEKLİĞİ
Fall Height (mm)
3000

OTURMA ALANI
Settle Area (mm)
9400x10425

ÜRÜN ADI
Product Name
Gökkuşağı Serisi

KAPASİTE
Number of User
65

TEPE YÜKSEKLİĞİ
Hill Height (mm)
5700

GÜVENLİK ALANI
Safety Area (mm)
13400x14425

ÜRÜN KODU
Product Code
GK3719

YAŞ ARALIĞI
Ages
5-12

DÜŞME YÜKSEKLİĞİ
Fall Height (mm)
4600

OTURMA ALANI
Settle Area (mm)
10620x13460

ÜRÜN ADI
Product Name
Gökkuşağı Serisi

KAPASİTE
Number of User
72

TEPE YÜKSEKLİĞİ
Hill Height (mm)
8230

GÜVENLİK ALANI
Safety Area (mm)
14620x17460



KREŞ SERİSİ

Nursery Series



KREŞ SERİSİ
Nursery Series



NR801

ÜRÜN KODU
Product Code
NR801

ÜRÜN ADI
Product Name
Kreş Serisi

YAŞ ARALIĞI
Ages
3-12

KAPASİTE
Number of User
14

DÜŞME YÜKSEKLİĞİ
Fall Height (mm)
1000

TEPE YÜKSEKLİĞİ
Hill Height (mm)
3810

OTURMA ALANI
Settle Area (mm)
5080x2160

GÜVENLİK ALANI
Safety Area (mm)
9080x6160

KREŞ SERİSİ
Nursery Series

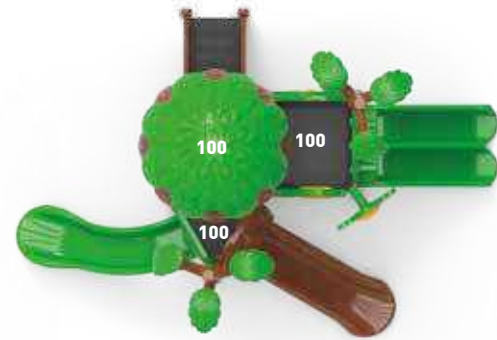

NR802



KREŞ SERİSİ
Nursery Series

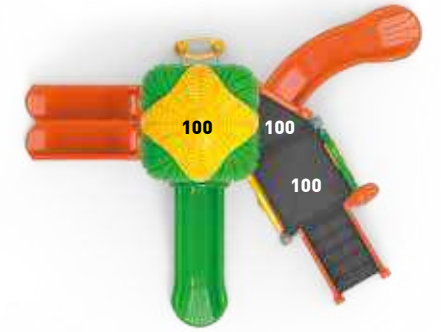

NR803

ÜRÜN KODU
Product Code
NR802

YAŞ ARALIĞI
Ages
3-12

DÜŞME YÜKSEKLİĞİ
Fall Height (mm)
1000

OTURMA ALANI
Settle Area (mm)
5930x4050

ÜRÜN ADI
Product Name
Kreş Serisi

KAPASİTE
Number of User
22

TEPE YÜKSEKLİĞİ
Hill Height (mm)
3690

GÜVENLİK ALANI
Safety Area (mm)
9930x8050

ÜRÜN KODU
Product Code
NR803

YAŞ ARALIĞI
Ages
3-12

DÜŞME YÜKSEKLİĞİ
Fall Height (mm)
1000

OTURMA ALANI
Settle Area (mm)
5320x4330

ÜRÜN ADI
Product Name
Kreş Serisi

KAPASİTE
Number of User
24

TEPE YÜKSEKLİĞİ
Hill Height (mm)
3700

GÜVENLİK ALANI
Safety Area (mm)
9320x8330

KREŞ SERİSİ
Nursery Series

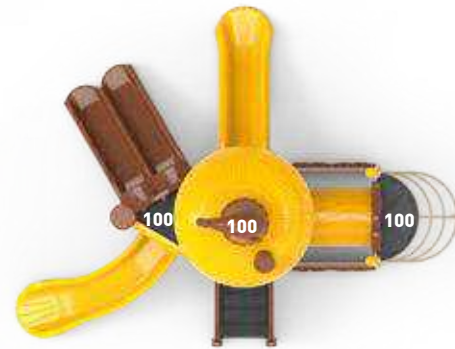

NR804



KREŞ SERİSİ
Nursery Series



NR805

ÜRÜN KODU
Product Code
NR804

YAŞ ARALIĞI
Ages
3-12

DÜŞME YÜKSEKLİĞİ
Fall Height (mm)
1000

OTURMA ALANI
Settle Area (mm)
5760x4450

ÜRÜN ADI
Product Name
Kreş Serisi

KAPASİTE
Number of User
22

TEPE YÜKSEKLİĞİ
Hill Height (mm)
4125

GÜVENLİK ALANI
Safety Area (mm)
9760x8450

ÜRÜN KODU
Product Code
NR805

YAŞ ARALIĞI
Ages
3-12

DÜŞME YÜKSEKLİĞİ
Fall Height (mm)
1000

OTURMA ALANI
Settle Area (mm)
5100x5300

ÜRÜN ADI
Product Name
Kreş Serisi

KAPASİTE
Number of User
24

TEPE YÜKSEKLİĞİ
Hill Height (mm)
4200

GÜVENLİK ALANI
Safety Area (mm)
9100x9300

KREŞ SERİSİ
Nursery Series



KREŞ SERİSİ
Nursery Series

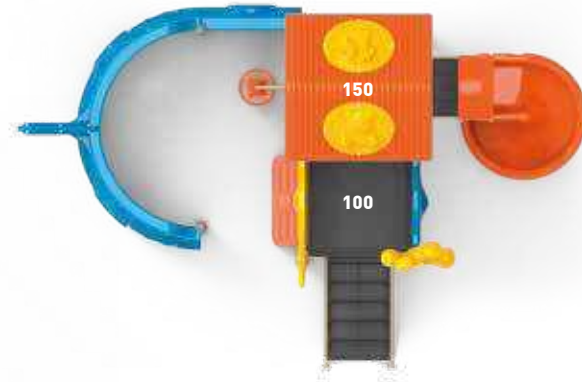

NR806

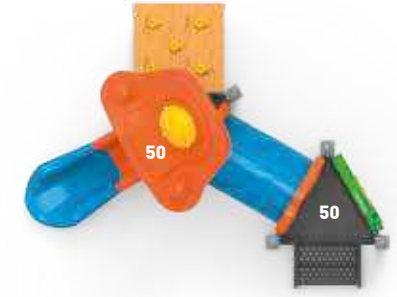

NR807

ÜRÜN KODU
Product Code
NR806

YAŞ ARALIĞI
Ages
3-12

DÜŞME YÜKSEKLİĞİ
Fall Height (mm)
1500

OTURMA ALANI
Settle Area (mm)
5780x3690

ÜRÜN ADI
Product Name
Kreş Serisi

KAPASİTE
Number of User
19

TEPE YÜKSEKLİĞİ
Hill Height (mm)
4070

GÜVENLİK ALANI
Safety Area (mm)
9780x7690

ÜRÜN KODU
Product Code
NR807

YAŞ ARALIĞI
Ages
3-12

DÜŞME YÜKSEKLİĞİ
Fall Height (mm)
500

OTURMA ALANI
Settle Area (mm)
3835x3010

ÜRÜN ADI
Product Name
Kreş Serisi

KAPASİTE
Number of User
13

TEPE YÜKSEKLİĞİ
Hill Height (mm)
3390

GÜVENLİK ALANI
Safety Area (mm)
7835x7010

KREŞ SERİSİ
Nursery Series

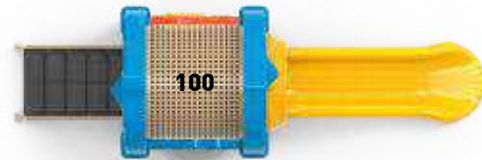

NR808



KREŞ SERİSİ
Nursery Series



NR809

ÜRÜN KODU
Product Code
NR808

YAŞ ARALIĞI
Ages
3-12

DÜŞME YÜKSEKLİĞİ
Fall Height (mm)
1000

OTURMA ALANI
Settle Area (mm)
1517x4460

ÜRÜN ADI
Product Name
Kreş Serisi

KAPASİTE
Number of User
11

TEPE YÜKSEKLİĞİ
Hill Height (mm)
3870

GÜVENLİK ALANI
Safety Area (mm)
5517x8460

ÜRÜN KODU
Product Code
NR809

YAŞ ARALIĞI
Ages
3-12

DÜŞME YÜKSEKLİĞİ
Fall Height (mm)
1000

OTURMA ALANI
Settle Area (mm)
5200x2600

ÜRÜN ADI
Product Name
Kreş Serisi

KAPASİTE
Number of User
11

TEPE YÜKSEKLİĞİ
Hill Height (mm)
3520

GÜVENLİK ALANI
Safety Area (mm)
9200x6600

KREŞ SERİSİ
Nursery Series

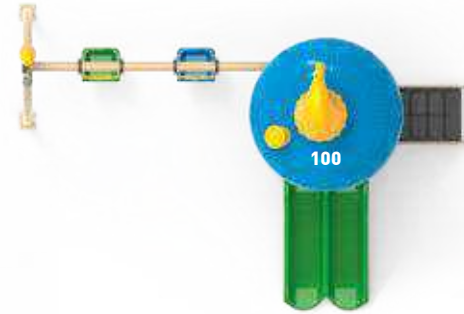

NR810

ÜRÜN KODU
Product Code
NR810

YAŞ ARALIĞI
Ages
3-12

DÜŞME YÜKSEKLİĞİ
Fall Height (mm)
1000

OTURMA ALANI
Settle Area (mm)
5380x3650

ÜRÜN ADI
Product Name
Kreş Serisi

KAPASİTE
Number of User
13

TEPE YÜKSEKLİĞİ
Hill Height (mm)
4100

GÜVENLİK ALANI
Safety Area (mm)
9380x7650



KREŞ SERİSİ
Nursery Series



NR811

ÜRÜN KODU
Product Code
NR811

YAŞ ARALIĞI
Ages
3-12

DÜŞME YÜKSEKLİĞİ
Fall Height (mm)
1000

OTURMA ALANI
Settle Area (mm)
7290x4420

ÜRÜN ADI
Product Name
Kreş Serisi

KAPASİTE
Number of User
13

TEPE YÜKSEKLİĞİ
Hill Height (mm)
3310

GÜVENLİK ALANI
Safety Area (mm)
11290x8420



TABIAT SERİSİ

Nature Series



TABIAT SERİSİ
Nature Series

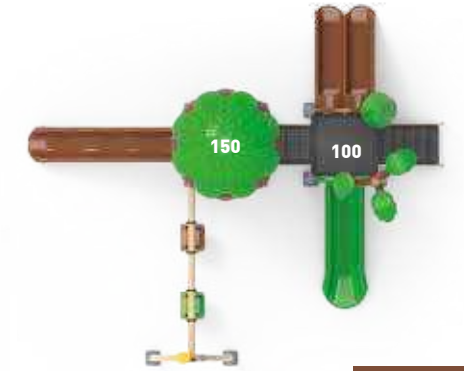

NT901

ÜRÜN KODU
Product Code
NT901

YAŞ ARALIĞI
Ages
3-12

DÜŞME YÜKSEKLİĞİ
Fall Height (mm)
1500

OTURMA ALANI
Settle Area (mm)
6990x6040

ÜRÜN ADI
Product Name
Tabiat Serisi

KAPASİTE
Number of User
20

TEPE YÜKSEKLİĞİ
Hill Height (mm)
4450

GÜVENLİK ALANI
Safety Area (mm)
10990x10040

TABIAT SERİSİ
Nature Series



NT902



TABIAT SERİSİ
Nature Series

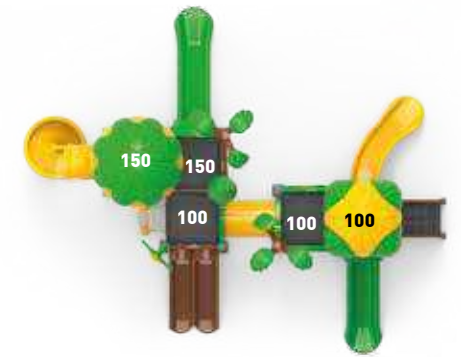

NT903

ÜRÜN KODU
Product Code
NT902

YAŞ ARALIĞI
Ages
5-12

DÜŞME YÜKSEKLİĞİ
Fall Height (mm)
1500

OTURMA ALANI
Settle Area (mm)
4750x8520

ÜRÜN ADI
Product Name
Tabiat Serisi

KAPASİTE
Number of User
26

TEPE YÜKSEKLİĞİ
Hill Height (mm)
4450

GÜVENLİK ALANI
Safety Area (mm)
8750x12520

ÜRÜN KODU
Product Code
NT903

YAŞ ARALIĞI
Ages
5-12

DÜŞME YÜKSEKLİĞİ
Fall Height (mm)
1500

OTURMA ALANI
Settle Area (mm)
8610x7060

ÜRÜN ADI
Product Name
Tabiat Serisi

KAPASİTE
Number of User
36

TEPE YÜKSEKLİĞİ
Hill Height (mm)
4500

GÜVENLİK ALANI
Safety Area (mm)
12610x11060

TABIAT SERİSİ
Nature Series



NT904



TABIAT SERİSİ
Nature Series



NT905

ÜRÜN KODU
Product Code
NT904

YAŞ ARALIĞI
Ages
5-12

DÜŞME YÜKSEKLİĞİ
Fall Height (mm)
2000

OTURMA ALANI
Settle Area (mm)
11970x8210

ÜRÜN ADI
Product Name
Tabiat Serisi

KAPASİTE
Number of User
32

TEPE YÜKSEKLİĞİ
Hill Height (mm)
5945

GÜVENLİK ALANI
Safety Area (mm)
15970x12210

ÜRÜN KODU
Product Code
NT905

YAŞ ARALIĞI
Ages
5-12

DÜŞME YÜKSEKLİĞİ
Fall Height (mm)
2000

OTURMA ALANI
Settle Area (mm)
6925x5585

ÜRÜN ADI
Product Name
Tabiat Serisi

KAPASİTE
Number of User
30

TEPE YÜKSEKLİĞİ
Hill Height (mm)
4965

GÜVENLİK ALANI
Safety Area (mm)
10925x9585

TABIAT SERİSİ
Nature Series



NT906

NT907



TABIAT SERİSİ
Nature Series



ÜRÜN KODU
Product Code
NT906

YAŞ ARALIĞI
Ages
5-12

DÜŞME YÜKSEKLİĞİ
Fall Height (mm)
2000

OTURMA ALANI
Settle Area (mm)
7155x11850

ÜRÜN ADI
Product Name
Tabiat Serisi

KAPASİTE
Number of User
40

TEPE YÜKSEKLİĞİ
Hill Height (mm)
4965

GÜVENLİK ALANI
Safety Area (mm)
11155x15850

ÜRÜN KODU
Product Code
NT907

YAŞ ARALIĞI
Ages
5-12

DÜŞME YÜKSEKLİĞİ
Fall Height (mm)
2000

OTURMA ALANI
Settle Area (mm)
17790x14750

ÜRÜN ADI
Product Name
Tabiat Serisi

KAPASİTE
Number of User
88

TEPE YÜKSEKLİĞİ
Hill Height (mm)
5940

GÜVENLİK ALANI
Safety Area (mm)
21790x18750

TABIAT SERİSİ
Nature Series

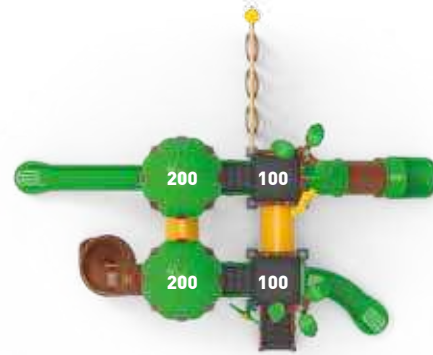

NT908



TABIAT SERİSİ
Nature Series



NT909

ÜRÜN KODU
Product Code
NT908

YAŞ ARALIĞI
Ages
5-12

DÜŞME YÜKSEKLİĞİ
Fall Height (mm)
2000

OTURMA ALANI
Settle Area (mm)
9530x7720

ÜRÜN ADI
Product Name
Tabiat Serisi

KAPASİTE
Number of User
40

TEPE YÜKSEKLİĞİ
Hill Height (mm)
4960

GÜVENLİK ALANI
Safety Area (mm)
13530x11720

ÜRÜN KODU
Product Code
NT909

YAŞ ARALIĞI
Ages
5-12

DÜŞME YÜKSEKLİĞİ
Fall Height (mm)
1500

OTURMA ALANI
Settle Area (mm)
10110x7160

ÜRÜN ADI
Product Name
Tabiat Serisi

KAPASİTE
Number of User
66

TEPE YÜKSEKLİĞİ
Hill Height (mm)
5945

GÜVENLİK ALANI
Safety Area (mm)
14110x11160

TABIAT SERİSİ
Nature Series



TABIAT SERİSİ
Nature Series

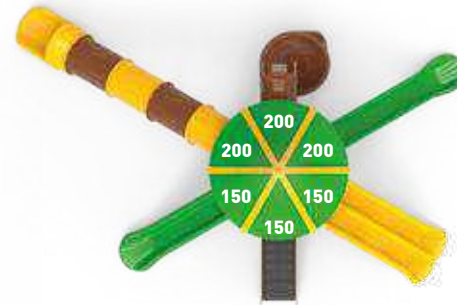

NT909-1



NT910

ÜRÜN KODU
Product Code
NT909-1

YAŞ ARALIĞI
Ages
5-12

DÜŞME YÜKSEKLİĞİ
Fall Height (mm)
2000

OTURMA ALANI
Settle Area (mm)
5900x8900

ÜRÜN ADI
Product Name
Tabiat Serisi

KAPASİTE
Number of User
19

TEPE YÜKSEKLİĞİ
Hill Height (mm)
5850

GÜVENLİK ALANI
Safety Area (mm)
9900x12900

ÜRÜN KODU
Product Code
NT910

YAŞ ARALIĞI
Ages
5-12

DÜŞME YÜKSEKLİĞİ
Fall Height (mm)
2500

OTURMA ALANI
Settle Area (mm)
10070x11700

ÜRÜN ADI
Product Name
Tabiat Serisi

KAPASİTE
Number of User
66

TEPE YÜKSEKLİĞİ
Hill Height (mm)
6390

GÜVENLİK ALANI
Safety Area (mm)
14070x15700

TABIAT SERİSİ
Nature Series



TABIAT SERİSİ
Nature Series



NT911

NT912

ÜRÜN KODU
Product Code
NT911

YAŞ ARALIĞI
Ages
5-12

DÜŞME YÜKSEKLİĞİ
Fall Height (mm)
3000

OTURMA ALANI
Settle Area (mm)
13160x16060

ÜRÜN ADI
Product Name
Tabiat Serisi

KAPASİTE
Number of User
92

TEPE YÜKSEKLİĞİ
Hill Height (mm)
5960

GÜVENLİK ALANI
Safety Area (mm)
17160x20060

ÜRÜN KODU
Product Code
NT912

YAŞ ARALIĞI
Ages
5-12

DÜŞME YÜKSEKLİĞİ
Fall Height (mm)
2000

OTURMA ALANI
Settle Area (mm)
9000x10125

ÜRÜN ADI
Product Name
Tabiat Serisi

KAPASİTE
Number of User
46

TEPE YÜKSEKLİĞİ
Hill Height (mm)
4970

GÜVENLİK ALANI
Safety Area (mm)
13000x14125

TABIAT SERİSİ
Nature Series



NT913

ÜRÜN KODU
Product Code
NT913

YAŞ ARALIĞI
Ages
5-12

DÜŞME YÜKSEKLİĞİ
Fall Height (mm)
1500

OTURMA ALANI
Settle Area (mm)
10750x7900

ÜRÜN ADI
Product Name
Tabiat Serisi

KAPASİTE
Number of User
52

TEPE YÜKSEKLİĞİ
Hill Height (mm)
4940

GÜVENLİK ALANI
Safety Area (mm)
14750x11900



TABIAT SERİSİ
Nature Series

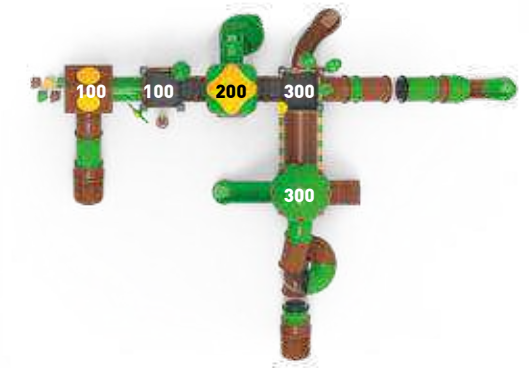

NT914

ÜRÜN KODU
Product Code
NT914

YAŞ ARALIĞI
Ages
5-12

DÜŞME YÜKSEKLİĞİ
Fall Height (mm)
3000

OTURMA ALANI
Settle Area (mm)
15110x10950

ÜRÜN ADI
Product Name
Tabiat Serisi

KAPASİTE
Number of User
72

TEPE YÜKSEKLİĞİ
Hill Height (mm)
5970

GÜVENLİK ALANI
Safety Area (mm)
19110x14950



LOKOMOTİF SERİSİ

Locomotive Series



LOKOMOTİF SERİSİ
Locomotive Series



LC1001

ÜRÜN KODU
Product Code
LC1001

ÜRÜN ADI
Product Name
Lokomotif Serisi

YAŞ ARALIĞI
Ages
5-12

KAPASİTE
Number of User
20

DÜŞME YÜKSEKLİĞİ
Fall Height (mm)
1500

TEPE YÜKSEKLİĞİ
Hill Height (mm)
4600

OTURMA ALANI
Settle Area (mm)
7100x4030

GÜVENLİK ALANI
Safety Area (mm)
11100x7030

LOKOMOTİF SERİSİ
Locomotive Series

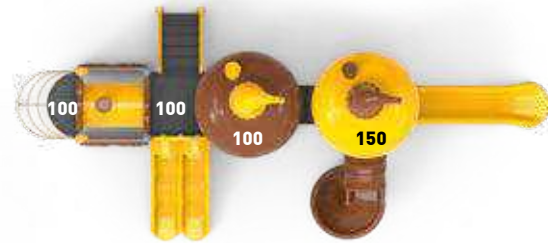

LC1002



LOKOMOTİF SERİSİ
Locomotive Series

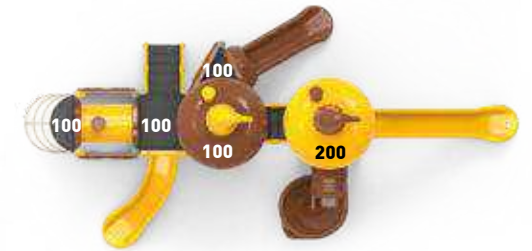

LC1003

ÜRÜN KODU
Product Code
LC1002

YAŞ ARALIĞI
Ages
5-12

DÜŞME YÜKSEKLİĞİ
Fall Height (mm)
1500

OTURMA ALANI
Settle Area (mm)
9100x4010

ÜRÜN ADI
Product Name
Lokomotif Serisi

KAPASİTE
Number of User
32

TEPE YÜKSEKLİĞİ
Hill Height (mm)
4600

GÜVENLİK ALANI
Safety Area (mm)
13100x8010

ÜRÜN KODU
Product Code
LC1003

YAŞ ARALIĞI
Ages
5-12

DÜŞME YÜKSEKLİĞİ
Fall Height (mm)
2000

OTURMA ALANI
Settle Area (mm)
5330x9880

ÜRÜN ADI
Product Name
Lokomotif Serisi

KAPASİTE
Number of User
32

TEPE YÜKSEKLİĞİ
Hill Height (mm)
5100

GÜVENLİK ALANI
Safety Area (mm)
9330x13880

LOKOMOTİF SERİSİ
Locomotive Series

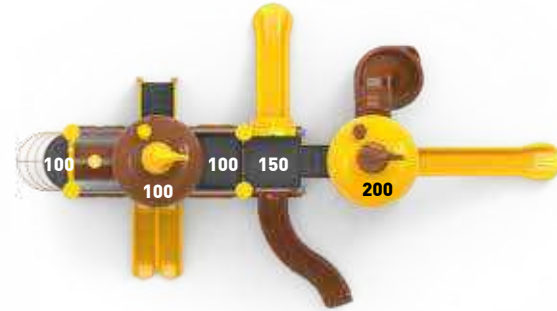

LC1004

ÜRÜN KODU
Product Code
LC1004

YAŞ ARALIĞI
Ages
5-12

DÜŞME YÜKSEKLİĞİ
Fall Height (mm)
2000

OTURMA ALANI
Settle Area (mm)
10870x6070

ÜRÜN ADI
Product Name
Lokomotif Serisi

KAPASİTE
Number of User
38

TEPE YÜKSEKLİĞİ
Hill Height (mm)
5110

GÜVENLİK ALANI
Safety Area (mm)
14870x10070



LOKOMOTİF SERİSİ
Locomotive Series

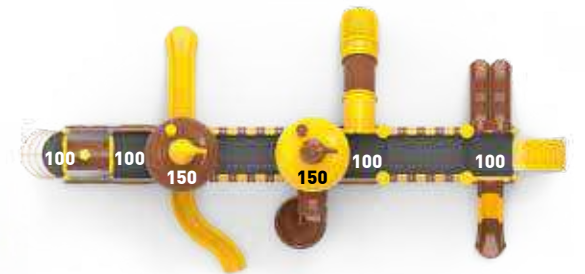

LC1005

ÜRÜN KODU
Product Code
LC1005

YAŞ ARALIĞI
Ages
5-12

DÜŞME YÜKSEKLİĞİ
Fall Height (mm)
1500

OTURMA ALANI
Settle Area (mm)
13370x6520

ÜRÜN ADI
Product Name
Lokomotif Serisi

KAPASİTE
Number of User
55

TEPE YÜKSEKLİĞİ
Hill Height (mm)
4600

GÜVENLİK ALANI
Safety Area (mm)
17370x10520



ROBOT SERİSİ

Robot Series



ROBOT SERİSİ
Robot Series



RB1101

ÜRÜN KODU
Product Code
RB1101

YAŞ ARALIĞI
Ages
5-12

DÜŞME YÜKSEKLİĞİ
Fall Height (mm)
1500

OTURMA ALANI
Settle Area (mm)
7260x5130

ÜRÜN ADI
Product Name
Robot Serisi

KAPASİTE
Number of User
28

TEPE YÜKSEKLİĞİ
Hill Height (mm)
4680

GÜVENLİK ALANI
Safety Area (mm)
11260x9130

ROBOT SERİSİ
Robot Series



RB1102

ÜRÜN KODU
Product Code
RB1102

YAŞ ARALIĞI
Ages
5-12

DÜŞME YÜKSEKLİĞİ
Fall Height (mm)
1500

OTURMA ALANI
Settle Area (mm)
6430x5380

ÜRÜN ADI
Product Name
Robot Serisi

KAPASİTE
Number of User
25

TEPE YÜKSEKLİĞİ
Hill Height (mm)
4680

GÜVENLİK ALANI
Safety Area (mm)
10430x9380



ROBOT SERİSİ
Robot Series

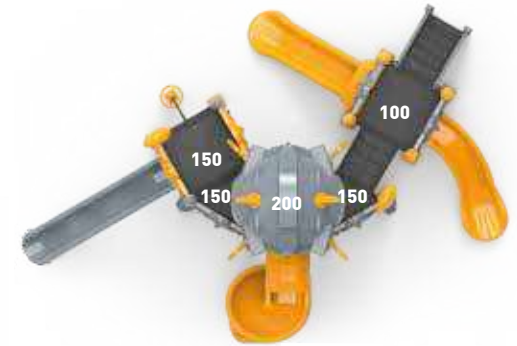

RB1103

ÜRÜN KODU
Product Code
RB1103

YAŞ ARALIĞI
Ages
5-12

DÜŞME YÜKSEKLİĞİ
Fall Height (mm)
2000

OTURMA ALANI
Settle Area (mm)
8000x5300

ÜRÜN ADI
Product Name
Robot Serisi

KAPASİTE
Number of User
41

TEPE YÜKSEKLİĞİ
Hill Height (mm)
5135

GÜVENLİK ALANI
Safety Area (mm)
12000x9300

ROBOT SERİSİ
Robot Series



RB1104



ROBOT SERİSİ
Robot Series



RB1105

ÜRÜN KODU
Product Code
RB1104

YAŞ ARALIĞI
Ages
5-12

DÜŞME YÜKSEKLİĞİ
Fall Height (mm)
2500

OTURMA ALANI
Settle Area (mm)
10730x8050

ÜRÜN ADI
Product Name
Robot Serisi

KAPASİTE
Number of User
43

TEPE YÜKSEKLİĞİ
Hill Height (mm)
5680

GÜVENLİK ALANI
Safety Area (mm)
14730x12050

ÜRÜN KODU
Product Code
RB1105

YAŞ ARALIĞI
Ages
5-12

DÜŞME YÜKSEKLİĞİ
Fall Height (mm)
3000

OTURMA ALANI
Settle Area (mm)
10695x12450

ÜRÜN ADI
Product Name
Robot Serisi

KAPASİTE
Number of User
71

TEPE YÜKSEKLİĞİ
Hill Height (mm)
5185

GÜVENLİK ALANI
Safety Area (mm)
14695x16450

ROBOT SERİSİ
Robot Series



RB1106

RB1107



ROBOT SERİSİ
Robot Series

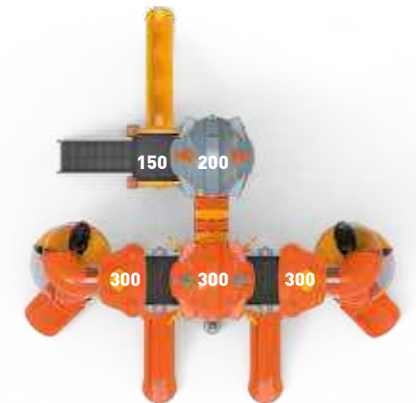

ÜRÜN KODU
Product Code
RB1106

YAŞ ARALIĞI
Ages
5-12

DÜŞME YÜKSEKLİĞİ
Fall Height (mm)
3000

OTURMA ALANI
Settle Area (mm)
14030x7880

ÜRÜN ADI
Product Name
Robot Serisi

KAPASİTE
Number of User
80

TEPE YÜKSEKLİĞİ
Hill Height (mm)
6100

GÜVENLİK ALANI
Safety Area (mm)
18030x11880

ÜRÜN KODU
Product Code
RB1107

YAŞ ARALIĞI
Ages
5-12

DÜŞME YÜKSEKLİĞİ
Fall Height (mm)
3000

OTURMA ALANI
Settle Area (mm)
8850x8200

ÜRÜN ADI
Product Name
Robot Serisi

KAPASİTE
Number of User
55

TEPE YÜKSEKLİĞİ
Hill Height (mm)
6210

GÜVENLİK ALANI
Safety Area (mm)
12850x12200

YELKEN SERİSİ
Sail Series

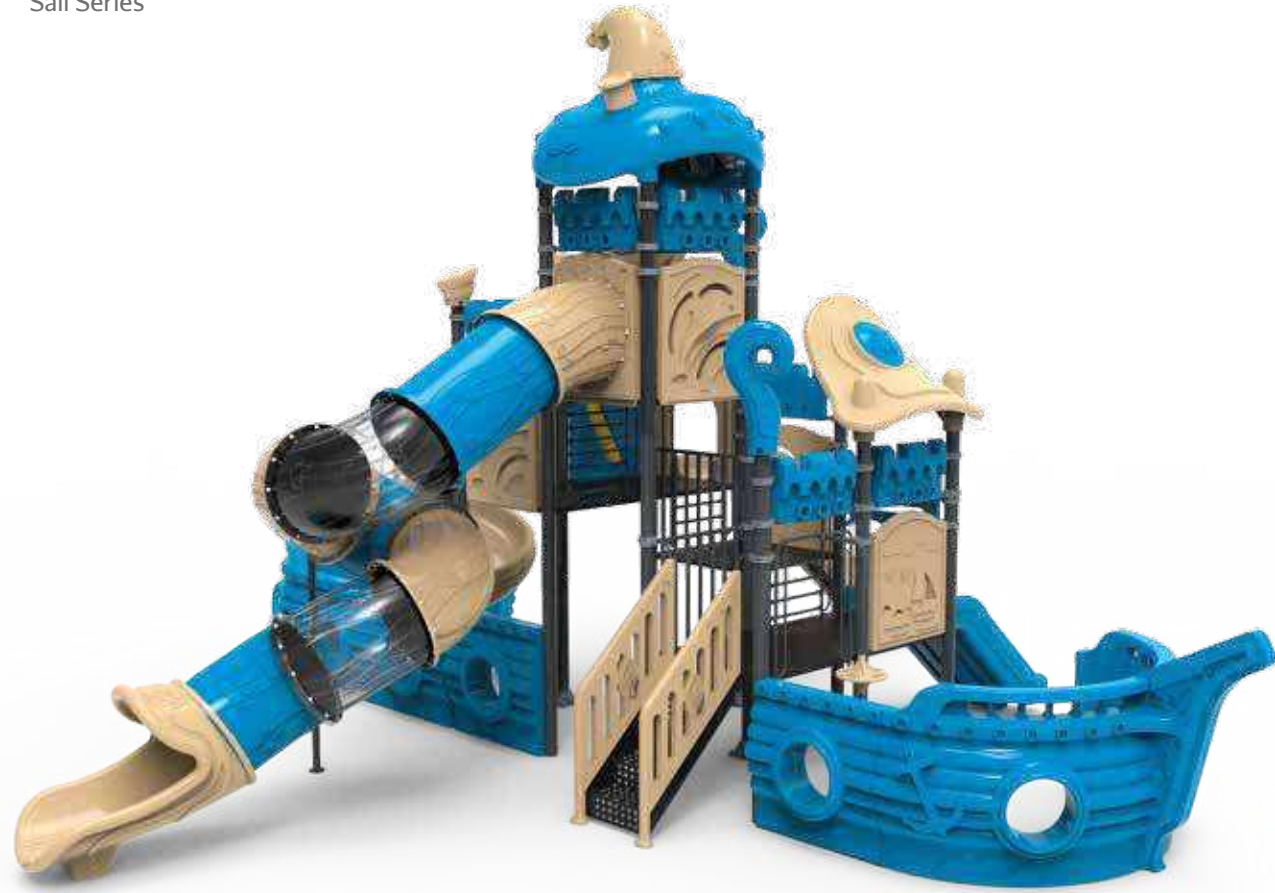

SL1202



YELKEN SERİSİ
Sail Series

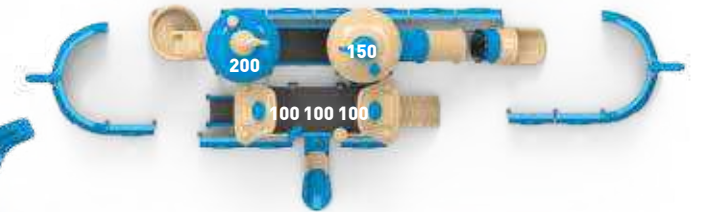

SL1203

ÜRÜN KODU
Product Code
SL1202

YAŞ ARALIĞI
Ages
5-12

DÜŞME YÜKSEKLİĞİ
Fall Height (mm)
3000

OTURMA ALANI
Settle Area (mm)
9775x10540

ÜRÜN ADI
Product Name
Yelken Serisi

KAPASİTE
Number of User
42

TEPE YÜKSEKLİĞİ
Hill Height (mm)
6150

GÜVENLİK ALANI
Safety Area (mm)
13775x14540

ÜRÜN KODU
Product Code
SL1203

YAŞ ARALIĞI
Ages
5-12

DÜŞME YÜKSEKLİĞİ
Fall Height (mm)
2000

OTURMA ALANI
Settle Area (mm)
5100x15000

ÜRÜN ADI
Product Name
Yelken Serisi

KAPASİTE
Number of User
44

TEPE YÜKSEKLİĞİ
Hill Height (mm)
5000

GÜVENLİK ALANI
Safety Area (mm)
9100x19000

YELKEN SERİSİ
Sail Series



YELKEN SERİSİ
Sail Series

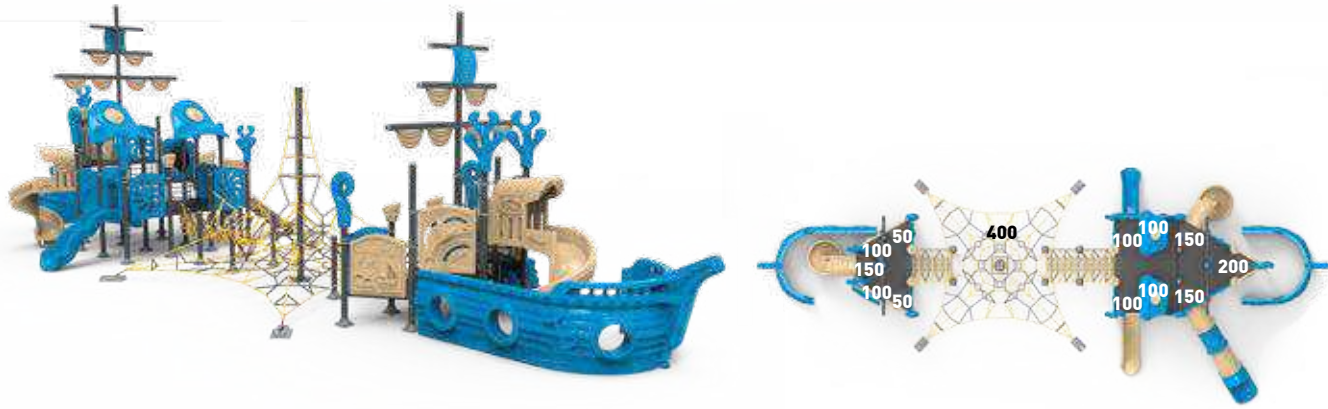

SL1204

SL1205

ÜRÜN KODU
Product Code
SL1204

YAŞ ARALIĞI
Ages
5-12

DÜŞME YÜKSEKLİĞİ
Fall Height (mm)
2000

OTURMA ALANI
Settle Area (mm)
7200x19800

ÜRÜN ADI
Product Name
Yelken Serisi

KAPASİTE
Number of User
82

TEPE YÜKSEKLİĞİ
Hill Height (mm)
6000

GÜVENLİK ALANI
Safety Area (mm)
11200x23800

ÜRÜN KODU
Product Code
SL1205

YAŞ ARALIĞI
Ages
5-12

DÜŞME YÜKSEKLİĞİ
Fall Height (mm)
2500

OTURMA ALANI
Settle Area (mm)
9200x13500

ÜRÜN ADI
Product Name
Yelken Serisi

KAPASİTE
Number of User
56

TEPE YÜKSEKLİĞİ
Hill Height (mm)
6000

GÜVENLİK ALANI
Safety Area (mm)
13200x17500

YELKEN SERİSİ
Sail Series



SL1206

ÜRÜN KODU
Product Code
SL1206

YAŞ ARALIĞI
Ages
5-12

DÜŞME YÜKSEKLİĞİ
Fall Height (mm)
2000

OTURMA ALANI
Settle Area (mm)
7350x11360

ÜRÜN ADI
Product Name
Yelken Serisi

KAPASİTE
Number of User
54

TEPE YÜKSEKLİĞİ
Hill Height (mm)
6000

GÜVENLİK ALANI
Safety Area (mm)
13350x15360



YELKEN SERİSİ
Sail Series



SL1207

ÜRÜN KODU
Product Code
SL1207

YAŞ ARALIĞI
Ages
5-12

DÜŞME YÜKSEKLİĞİ
Fall Height (mm)
2000

OTURMA ALANI
Settle Area (mm)
8000x10390

ÜRÜN ADI
Product Name
Yelken Serisi

KAPASİTE
Number of User
48

TEPE YÜKSEKLİĞİ
Hill Height (mm)
6000

GÜVENLİK ALANI
Safety Area (mm)
12000x14390



HİSAR SERİSİ

Fortress Series



HİSAR SERİSİ
Fortress Series



FR1301

ÜRÜN KODU
Product Code
FR1301

YAŞ ARALIĞI
Ages
5-12

DÜŞME YÜKSEKLİĞİ
Fall Height (mm)
3000

OTURMA ALANI
Settle Area (mm)
6800x7800

ÜRÜN ADI
Product Name
Hisar Serisi

KAPASİTE
Number of User
34

TEPE YÜKSEKLİĞİ
Hill Height (mm)
7000

GÜVENLİK ALANI
Safety Area (mm)
10800x11800

HİSAR SERİSİ
Fortress Series



FR1302



HİSAR SERİSİ
Fortress Series

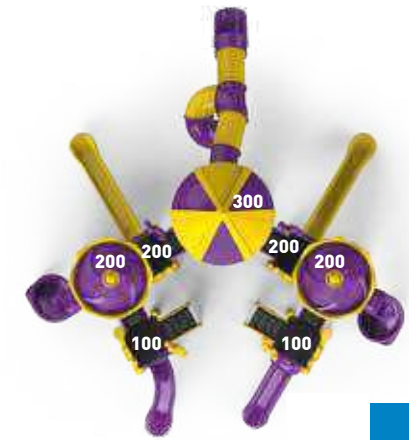

FR1303

ÜRÜN KODU
Product Code
FR1302

YAŞ ARALIĞI
Ages
5-12

DÜŞME YÜKSEKLİĞİ
Fall Height (mm)
3000

OTURMA ALANI
Settle Area (mm)
8500x9300

ÜRÜN ADI
Product Name
Hisar Serisi

KAPASİTE
Number of User
48

TEPE YÜKSEKLİĞİ
Hill Height (mm)
7000

GÜVENLİK ALANI
Safety Area (mm)
12500x13300

ÜRÜN KODU
Product Code
FR1303

YAŞ ARALIĞI
Ages
5-12

DÜŞME YÜKSEKLİĞİ
Fall Height (mm)
3000

OTURMA ALANI
Settle Area (mm)
10700x12000

ÜRÜN ADI
Product Name
Hisar Serisi

KAPASİTE
Number of User
60

TEPE YÜKSEKLİĞİ
Hill Height (mm)
7000

GÜVENLİK ALANI
Safety Area (mm)
14700x16000

HİSAR SERİSİ
Fortress Series



FR1304

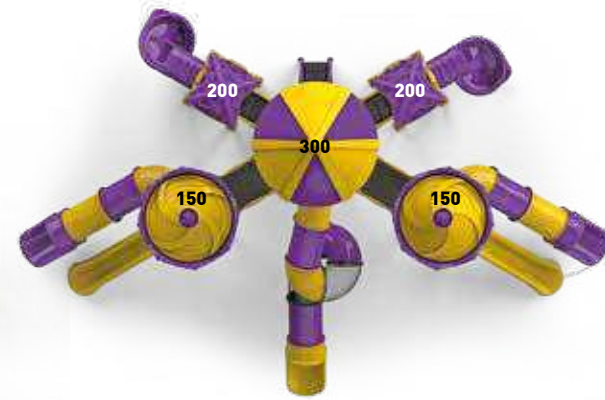

HİSAR SERİSİ
Fortress Series



FR1305

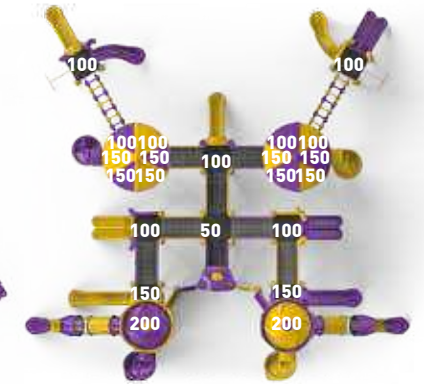

ÜRÜN KODU
Product Code
FR1304

YAŞ ARALIĞI
Ages
5-12

DÜŞME YÜKSEKLİĞİ
Fall Height (mm)
3000

OTURMA ALANI
Settle Area (mm)
8900x13700

ÜRÜN ADI
Product Name
Hisar Serisi

KAPASİTE
Number of User
58

TEPE YÜKSEKLİĞİ
Hill Height (mm)
7000

GÜVENLİK ALANI
Safety Area (mm)
12900x17700

ÜRÜN KODU
Product Code
FR1305

YAŞ ARALIĞI
Ages
5-12

DÜŞME YÜKSEKLİĞİ
Fall Height (mm)
2000

OTURMA ALANI
Settle Area (mm)
16000x17000

ÜRÜN ADI
Product Name
Hisar Serisi

KAPASİTE
Number of User
146

TEPE YÜKSEKLİĞİ
Hill Height (mm)
6000

GÜVENLİK ALANI
Safety Area (mm)
20000x21000

HİSAR SERİSİ
Fortress Series

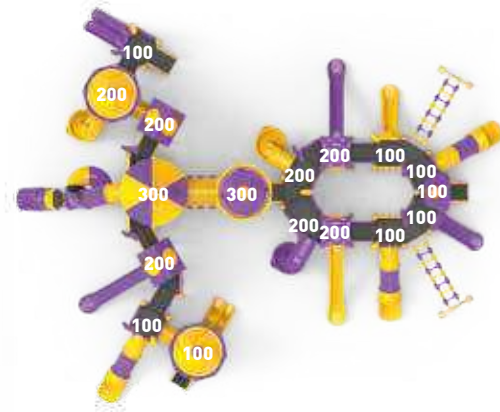

FR1308

ÜRÜN KODU
Product Code
FR1308

YAŞ ARALIĞI
Ages
5-12

DÜŞME YÜKSEKLİĞİ
Fall Height (mm)
3000

OTURMA ALANI
Settle Area (mm)
15500x19700

ÜRÜN ADI
Product Name
Hisar Serisi

KAPASİTE
Number of User
192

TEPE YÜKSEKLİĞİ
Hill Height (mm)
7000

GÜVENLİK ALANI
Safety Area (mm)
19500x23700



HİSAR SERİSİ
Fortress Series



FR1309

ÜRÜN KODU
Product Code
FR1309

YAŞ ARALIĞI
Ages
5-12

DÜŞME YÜKSEKLİĞİ
Fall Height (mm)
4000

OTURMA ALANI
Settle Area (mm)
13200x28300

ÜRÜN ADI
Product Name
Hisar Serisi

KAPASİTE
Number of User
168

TEPE YÜKSEKLİĞİ
Hill Height (mm)
8000

GÜVENLİK ALANI
Safety Area (mm)
17200x32300

HİSAR SERİSİ
Fortress Series



FR1310

ÜRÜN KODU
Product Code
FR1310

YAŞ ARALIĞI
Ages
5-12

DÜŞME YÜKSEKLİĞİ
Fall Height (mm)
3000

OTURMA ALANI
Settle Area (mm)
7340x10600

ÜRÜN ADI
Product Name
Hisar Serisi

KAPASİTE
Number of User
34

TEPE YÜKSEKLİĞİ
Hill Height (mm)
6940

GÜVENLİK ALANI
Safety Area (mm)
11340x14600



HİSAR SERİSİ
Fortress Series

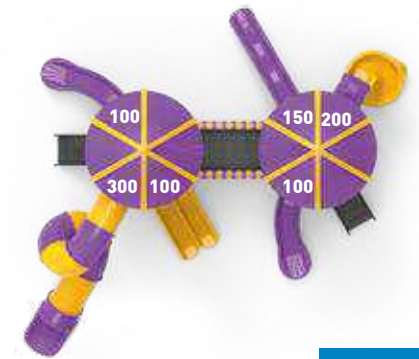

FR1311

ÜRÜN KODU
Product Code
FR1311

YAŞ ARALIĞI
Ages
5-12

DÜŞME YÜKSEKLİĞİ
Fall Height (mm)
3000

OTURMA ALANI
Settle Area (mm)
8130x8940

ÜRÜN ADI
Product Name
Hisar Serisi

KAPASİTE
Number of User
42

TEPE YÜKSEKLİĞİ
Hill Height (mm)
7000

GÜVENLİK ALANI
Safety Area (mm)
12130x12940

HİSAR SERİSİ
Fortress Series



FR1312

ÜRÜN KODU
Product Code
FR1312

YAŞ ARALIĞI
Ages
5-12

DÜŞME YÜKSEKLİĞİ
Fall Height (mm)
3000

OTURMA ALANI
Settle Area (mm)
11730x12150

ÜRÜN ADI
Product Name
Hisar Serisi

KAPASİTE
Number of User
65

TEPE YÜKSEKLİĞİ
Hill Height (mm)
6940

GÜVENLİK ALANI
Safety Area (mm)
14730x16150



HİSAR SERİSİ
Fortress Series



FR1313

ÜRÜN KODU
Product Code
FR1313

YAŞ ARALIĞI
Ages
5-12

DÜŞME YÜKSEKLİĞİ
Fall Height (mm)
3000

OTURMA ALANI
Settle Area (mm)
15165x16830

ÜRÜN ADI
Product Name
Hisar Serisi

KAPASİTE
Number of User
60

TEPE YÜKSEKLİĞİ
Hill Height (mm)
6950

GÜVENLİK ALANI
Safety Area (mm)
19165x20830



ÖZGÜR SERİSİ

Independent Series



ÖZGÜR SERİSİ

Independent Series

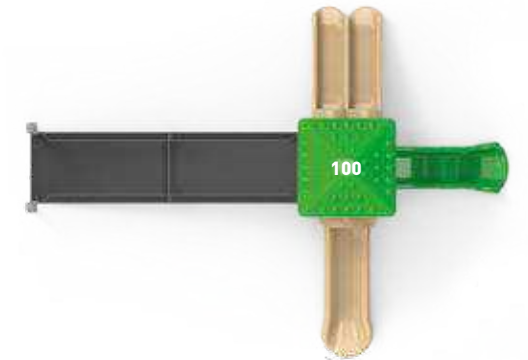

NP1401

ÜRÜN KODU
Product Code
NP1401

ÜRÜN ADI
Product Name
Özgür Serisi

YAŞ ARALIĞI
Ages
3-12

KAPASİTE
Number of User
24

DÜŞME YÜKSEKLİĞİ
Fall Height (mm)
1000

TEPE YÜKSEKLİĞİ
Hill Height (mm)
3314

OTURMA ALANI
Settle Area (mm)
5080x6976

GÜVENLİK ALANI
Safety Area (mm)
9080x10976

ÖZGÜR SERİSİ
Independent Series



ÖZGÜR SERİSİ
Independent Series

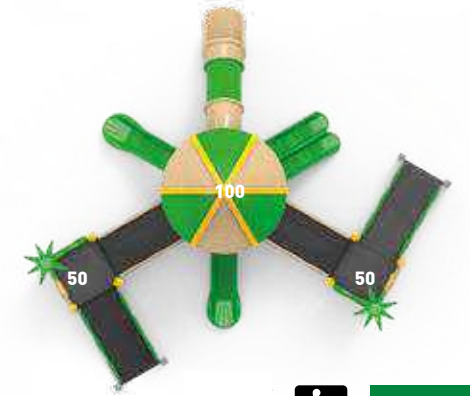
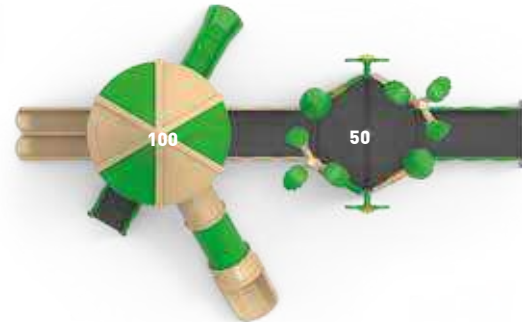

NP1402



ÜRÜN KODU
Product Code
NP1402

YAŞ ARALIĞI
Ages
3-12

DÜŞME YÜKSEKLİĞİ
Fall Height (mm)
1000

OTURMA ALANI
Settle Area (mm)
9825x6025

ÜRÜN ADI
Product Name
Özgür Serisi

KAPASİTE
Number of User
37

TEPE YÜKSEKLİĞİ
Hill Height (mm)
4945

GÜVENLİK ALANI
Safety Area (mm)
13825x10025

NP1403



ÜRÜN KODU
Product Code
NP1403

YAŞ ARALIĞI
Ages
3-12

DÜŞME YÜKSEKLİĞİ
Fall Height (mm)
1000

OTURMA ALANI
Settle Area (mm)
8450x9350

ÜRÜN ADI
Product Name
Özgür Serisi

KAPASİTE
Number of User
52

TEPE YÜKSEKLİĞİ
Hill Height (mm)
4950

GÜVENLİK ALANI
Safety Area (mm)
12450x13350

ÖZGÜR SERİSİ
Independent Series

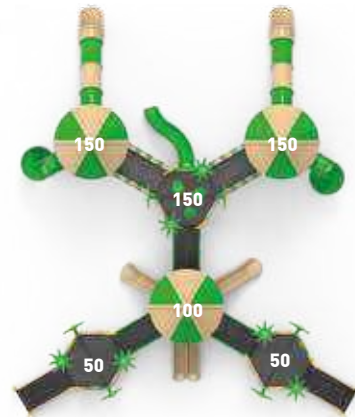

NP1404



ÜRÜN KODU
Product Code
NP1404

YAŞ ARALIĞI
Ages
5-12

DÜŞME YÜKSEKLİĞİ
Fall Height (mm)
1500

OTURMA ALANI
Settle Area (mm)
14980x12900

ÜRÜN ADI
Product Name
Özgür Serisi

KAPASİTE
Number of User
100

TEPE YÜKSEKLİĞİ
Hill Height (mm)
5445

GÜVENLİK ALANI
Safety Area (mm)
18980x16900



ÖZGÜR SERİSİ
Independent Series

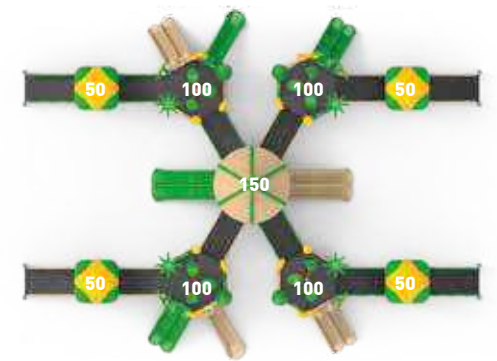

NP1405

ÜRÜN KODU
Product Code
NP1405

YAŞ ARALIĞI
Ages
5-12

DÜŞME YÜKSEKLİĞİ
Fall Height (mm)
1500

OTURMA ALANI
Settle Area (mm)
16450x12250

ÜRÜN ADI
Product Name
Özgür Serisi

KAPASİTE
Number of User
158

TEPE YÜKSEKLİĞİ
Hill Height (mm)
5445

GÜVENLİK ALANI
Safety Area (mm)
20450x16250

ÖZGÜR SERİSİ
Independent Series

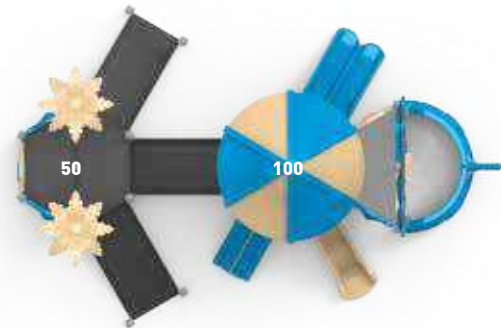

NP1406



ÜRÜN KODU
Product Code
NP1406

YAŞ ARALIĞI
Ages
3-12

DÜŞME YÜKSEKLİĞİ
Fall Height (mm)
1000

OTURMA ALANI
Settle Area (mm)
9100x5990

ÜRÜN ADI
Product Name
Özgür Serisi

KAPASİTE
Number of User
42

TEPE YÜKSEKLİĞİ
Hill Height (mm)
4945

GÜVENLİK ALANI
Safety Area (mm)
13100x9990



ÖZGÜR SERİSİ
Independent Series



NP1407

ÜRÜN KODU
Product Code
NP1407

YAŞ ARALIĞI
Ages
3-12

DÜŞME YÜKSEKLİĞİ
Fall Height (mm)
1000

OTURMA ALANI
Settle Area (mm)
8875x7595

ÜRÜN ADI
Product Name
Özgür Serisi

KAPASİTE
Number of User
38

TEPE YÜKSEKLİĞİ
Hill Height (mm)
4100

GÜVENLİK ALANI
Safety Area (mm)
12875x11595

ÖZGÜR SERİSİ
Independent Series

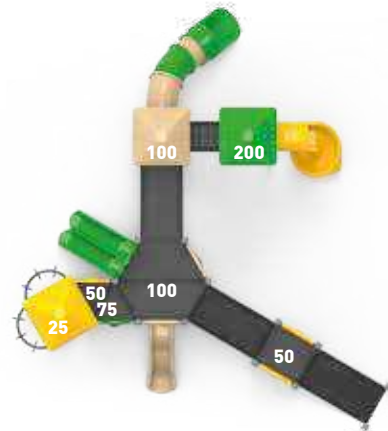

NP1408



ÜRÜN KODU
Product Code
NP1408

YAŞ ARALIĞI
Ages
5-12

DÜŞME YÜKSEKLİĞİ
Fall Height (mm)
2000

OTURMA ALANI
Settle Area (mm)
9450x8910

ÜRÜN ADI
Product Name
Özgür Serisi

KAPASİTE
Number of User
74

TEPE YÜKSEKLİĞİ
Hill Height (mm)
4320

GÜVENLİK ALANI
Safety Area (mm)
13450x12910



ÖZGÜR SERİSİ
Independent Series

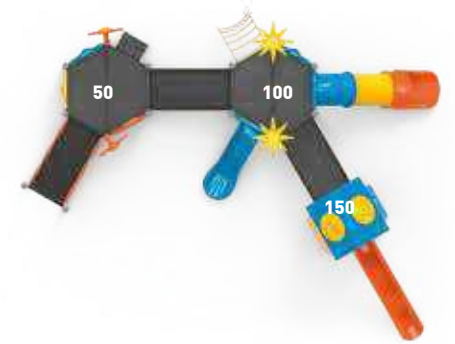

NP1409

ÜRÜN KODU
Product Code
NP1409

YAŞ ARALIĞI
Ages
5-12

DÜŞME YÜKSEKLİĞİ
Fall Height (mm)
1500

OTURMA ALANI
Settle Area (mm)
10130x6970

ÜRÜN ADI
Product Name
Özgür Serisi

KAPASİTE
Number of User
56

TEPE YÜKSEKLİĞİ
Hill Height (mm)
4010

GÜVENLİK ALANI
Safety Area (mm)
14130x10970



ÖZGÜR SERİSİ
Independent Series

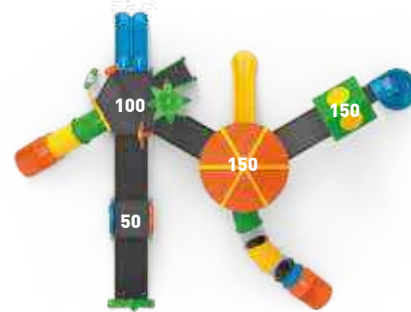

NP1410

ÜRÜN KODU
Product Code
NP1410

YAŞ ARALIĞI
Ages
5-12

DÜŞME YÜKSEKLİĞİ
Fall Height (mm)
1500

OTURMA ALANI
Settle Area (mm)
12760x9110

ÜRÜN ADI
Product Name
Özgür Serisi

KAPASİTE
Number of User
70

TEPE YÜKSEKLİĞİ
Hill Height (mm)
5440

GÜVENLİK ALANI
Safety Area (mm)
16760x13110



YAMAÇ SERİSİ

Slope Series



YAMAÇ SERİSİ

Slope Series



SP1501

ÜRÜN KODU
Product Code
SP1501

YAŞ ARALIĞI
Ages
5-12

DÜŞME YÜKSEKLİĞİ
Fall Height (mm)
1500

OTURMA ALANI
Settle Area (mm)
5500x6400

ÜRÜN ADI
Product Name
Yamaç Serisi

KAPASİTE
Number of User
23

TEPE YÜKSEKLİĞİ
Hill Height (mm)
3000

GÜVENLİK ALANI
Safety Area (mm)
9500x10400

YAMAÇ SERİSİ
Slope Series



YAMAÇ SERİSİ
Slope Series



SP1502

ÜRÜN KODU
Product Code
SP1502

YAŞ ARALIĞI
Ages
5-12

DÜŞME YÜKSEKLİĞİ
Fall Height (mm)
1500

OTURMA ALANI
Settle Area (mm)
5600x6400

ÜRÜN ADI
Product Name
Yamaç Serisi

KAPASİTE
Number of User
24

TEPE YÜKSEKLİĞİ
Hill Height (mm)
3000

GÜVENLİK ALANI
Safety Area (mm)
9600x10400



SP1503

ÜRÜN KODU
Product Code
SP1503

YAŞ ARALIĞI
Ages
5-12

DÜŞME YÜKSEKLİĞİ
Fall Height (mm)
1700

OTURMA ALANI
Settle Area (mm)
6400x6400

ÜRÜN ADI
Product Name
Yamaç Serisi

KAPASİTE
Number of User
23

TEPE YÜKSEKLİĞİ
Hill Height (mm)
3000

GÜVENLİK ALANI
Safety Area (mm)
10400x10400

YAMAÇ SERİSİ
Slope Series



SP1504

ÜRÜN KODU
Product Code
SP1504

YAŞ ARALIĞI
Ages
5-12

DÜŞME YÜKSEKLİĞİ
Fall Height (mm)
1500

OTURMA ALANI
Settle Area (mm)
5500x7200

ÜRÜN ADI
Product Name
Yamaç Serisi

KAPASİTE
Number of User
28

TEPE YÜKSEKLİĞİ
Hill Height (mm)
3000

GÜVENLİK ALANI
Safety Area (mm)
9500x11200



YAMAÇ SERİSİ
Slope Series



SP1505

ÜRÜN KODU
Product Code
SP1505

YAŞ ARALIĞI
Ages
5-12

DÜŞME YÜKSEKLİĞİ
Fall Height (mm)
1700

OTURMA ALANI
Settle Area (mm)
7100x10000

ÜRÜN ADI
Product Name
Yamaç Serisi

KAPASİTE
Number of User
37

TEPE YÜKSEKLİĞİ
Hill Height (mm)
3000

GÜVENLİK ALANI
Safety Area (mm)
11100x14000

YAMAÇ SERİSİ
Slope Series



SP1506



YAMAÇ SERİSİ
Slope Series



SP1507

ÜRÜN KODU
Product Code
SP1506

YAŞ ARALIĞI
Ages
5-12

DÜŞME YÜKSEKLİĞİ
Fall Height (mm)
1500

OTURMA ALANI
Settle Area (mm)
7565x8760

ÜRÜN ADI
Product Name
Yamaç Serisi

KAPASİTE
Number of User
24

TEPE YÜKSEKLİĞİ
Hill Height (mm)
4280

GÜVENLİK ALANI
Safety Area (mm)
11565x12760

ÜRÜN KODU
Product Code
SP1507

YAŞ ARALIĞI
Ages
5-12

DÜŞME YÜKSEKLİĞİ
Fall Height (mm)
1500

OTURMA ALANI
Settle Area (mm)
12300x12400

ÜRÜN ADI
Product Name
Yamaç Serisi

KAPASİTE
Number of User
58

TEPE YÜKSEKLİĞİ
Hill Height (mm)
3900

GÜVENLİK ALANI
Safety Area (mm)
16300x16400



OLİMPİYAT SERİSİ

Olympiad Series



OLİMPİYAT SERİSİ
Olympiad Series

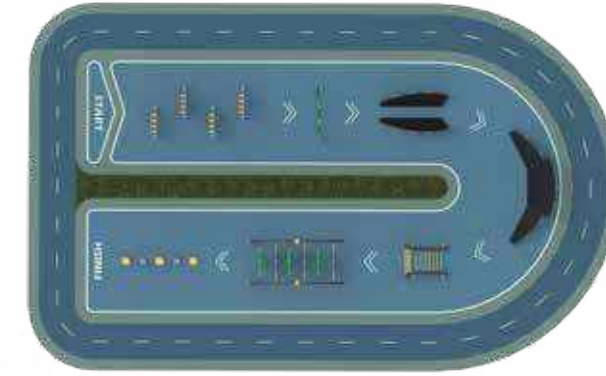

- 1 - (M) Slalom Koşu / Slalom Runnig
- 2 - (K) İp Duvarı / Rope Wall
- 3 - (A) Çapraz Koşu / Cross Jump
- 4 - (O) Köşe Dönüş Geçişi / Corner Pass
- 5 - (F) Tırmanma Ağı / Climbing Net
- 6 - (U) Simit Geçiş / Drilled Pass
- 7 - (P) Kütük Geçiş / Log Pass

YP1604

ÜRÜN KODU
Product Code
YP1604

ÜRÜN ADI
Product Name
Olimpiyat Serisi

YAŞ ARALIĞI
Ages
5-12

KAPASİTE
Number of User
18

DÜŞME YÜKSEKLİĞİ
Fall Height (mm)

TEPE YÜKSEKLİĞİ
Hill Height (mm)

OTURMA ALANI
Settle Area (mm)
11500x20500 - 235 m²

GÜVENLİK ALANI
Safety Area (mm)
15500x24500 - 380 m²

OLİMPİYAT SERİSİ
Olympiad Series



- 1 - (T) Yaylı Geçiş / Spring Pass
- 2 - (U) Simit Geçiş / Drilled Pass
- 3 - (G) Tırmanma Duvarı / Climbing Wall
- 4 - (Y) Yamaç Geçiş 2 / Slope Crossing 2
- 5 - (S) S Tüp Geçiş / S Tube Pass
- 6 - (Z) Yüksek İp Atlama / High Jump Rope
- 7 - (M) Slalom Koşu / Slalom Running
- 8 - (D) DNA Tırmanmalı Kaydırak / DNA Climbing Slide

YP1605



OLİMPİYAT SERİSİ
Olympiad Series

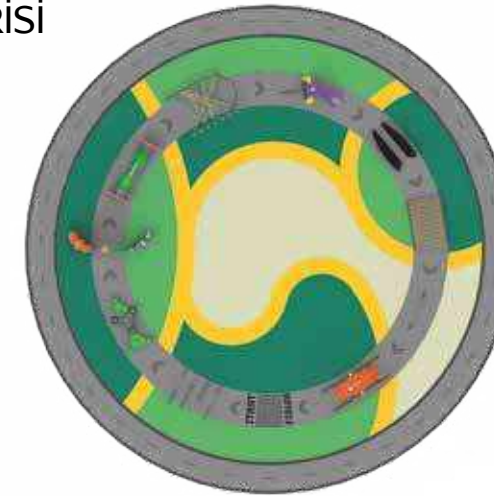

- 1 - (R) Labirent Geçiş / Labirent Pass
- 2 - (H) Galaksi Geçiş / Galaxy Pass
- 3 - (V) Yamaç Geçiş 1 / Slope Crossing 1
- 4 - (E) Eğimli Tüp Geçiş / Inclined Tube Pass
- 5 - (N) Karışık İp Geçiş / Mixed Rope Crossing
- 6 - (D) DNA Tırmanmalı Kaydırak / DNA Climbing Slide
- 7 - (A) Çapraz Koşu / Cross Jump
- 8 - (L) İp Yokuşu / Rope Uphill
- 9 - (B) Denge Yürüyüşü / Balance Walk
- 10 - (C) Dil Köprü / Tongue Bridge

YP1606

ÜRÜN KODU
Product Code
YP1605

YAŞ ARALIĞI
Ages
5-12

DÜŞME YÜKSEKLİĞİ
Fall Height (mm)

OTURMA ALANI
Settle Area (mm)
Ø20000-315 m2

ÜRÜN ADI
Product Name
Olimpiyat Serisi

KAPASİTE
Number of User
22

TEPE YÜKSEKLİĞİ
Hill Height (mm)

GÜVENLİK ALANI
Safety Area (mm)
Ø24000-450 m2

ÜRÜN KODU
Product Code
YP1606

YAŞ ARALIĞI
Ages
5-12

DÜŞME YÜKSEKLİĞİ
Fall Height (mm)

OTURMA ALANI
Settle Area (mm)
Ø25000-490 m2

ÜRÜN ADI
Product Name
Olimpiyat Serisi

KAPASİTE
Number of User
27

TEPE YÜKSEKLİĞİ
Hill Height (mm)

GÜVENLİK ALANI
Safety Area (mm)
Ø29000-660 m2

OLİMPİYAT SERİSİ
Olympiad Series



OLİMPİYAT SERİSİ
Olympiad Series

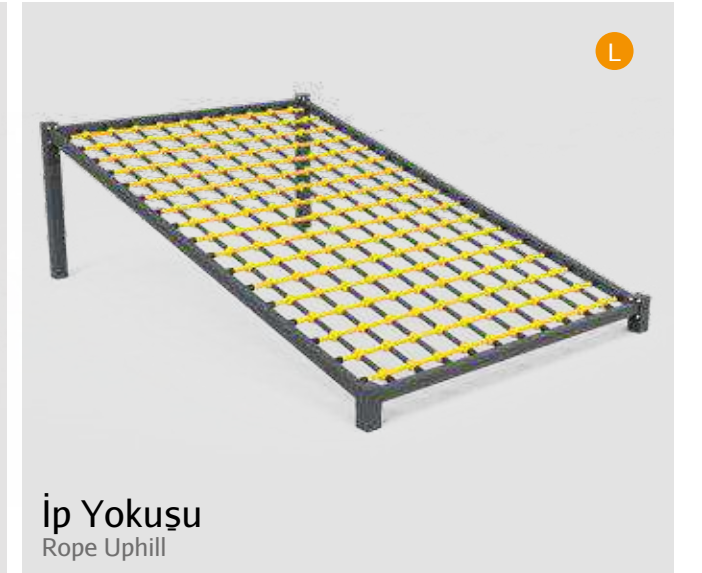
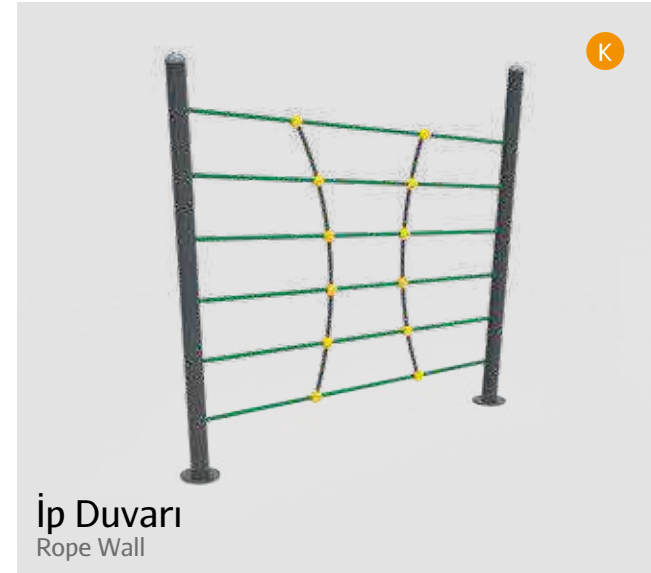

OLİMPİYAT SERİSİ
Olympiad Series



Köşe Dönüş Geçişi
Corner Pass



Kütük Geçiş
Log Pass



Labirent Geçiş
Labirent Pass



S Tüp Geçiş
S Tube Pass



Yaylı Geçiş
Spring Pass



Simit Geçiş
Drilled Pass

OLİMPİYAT SERİSİ
Olympiad Series



Yamaç Geçiş 1
Slope Crossing 1



Yamaç Geçiş 2
Slope Crossing 2

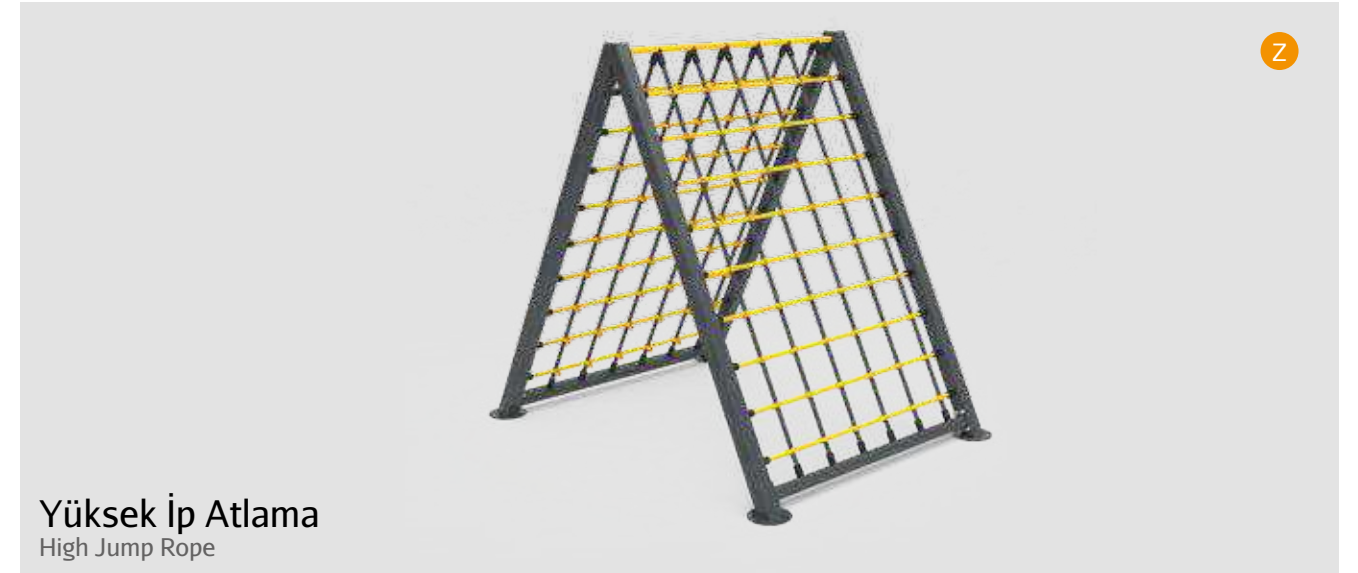

Yüksek İp Atlama
High Jump Rope





TOKİ SERİSİ

Toki Series

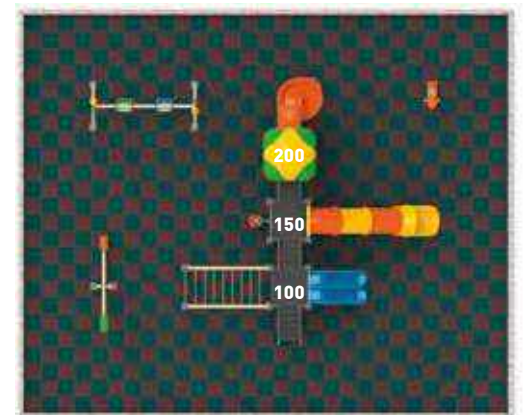

TOKİ SERİSİ
Toki Series

TK1701

ÜRÜN KODU
Product Code
TK1701

YAŞ ARALIĞI
Ages
5-12

DÜŞME YÜKSEKLİĞİ
Fall Height (mm)
2000

OTURMA ALANI
Settle Area (mm)
10570x8020

ÜRÜN ADI
Product Name
Toki Serisi

KAPASİTE
Number of User
33

TEPE YÜKSEKLİĞİ
Hill Height (mm)
4890

GÜVENLİK ALANI
Safety Area (mm)
14570x12020

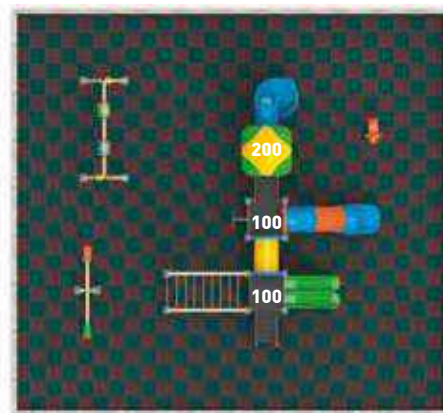

TOKİ SERİSİ
Toki Series

TK1702

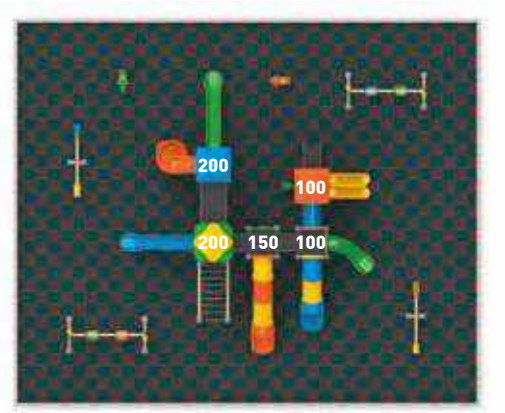

TOKİ SERİSİ
Toki Series

TK1703

ÜRÜN KODU
Product Code
TK1702

YAŞ ARALIĞI
Ages
5-12

DÜŞME YÜKSEKLİĞİ
Fall Height (mm)
2000

OTURMA ALANI
Settle Area (mm)
8500x9500

ÜRÜN ADI
Product Name
Toki Serisi

KAPASİTE
Number of User
34

TEPE YÜKSEKLİĞİ
Hill Height (mm)
4720

GÜVENLİK ALANI
Safety Area (mm)
12500x13500

ÜRÜN KODU
Product Code
TK1703

YAŞ ARALIĞI
Ages
5-12

DÜŞME YÜKSEKLİĞİ
Fall Height (mm)
2000

OTURMA ALANI
Settle Area (mm)
11400x14600

ÜRÜN ADI
Product Name
Toki Serisi

KAPASİTE
Number of User
58

TEPE YÜKSEKLİĞİ
Hill Height (mm)
4700

GÜVENLİK ALANI
Safety Area (mm)
15400x18600

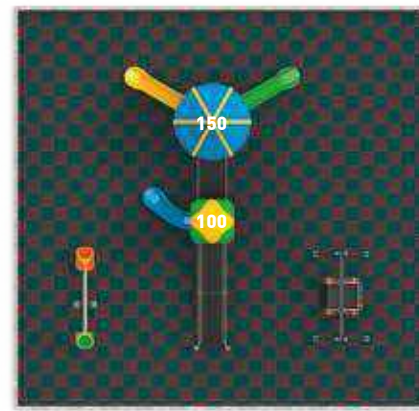

TOKİ SERİSİ
Toki Series

TK1704

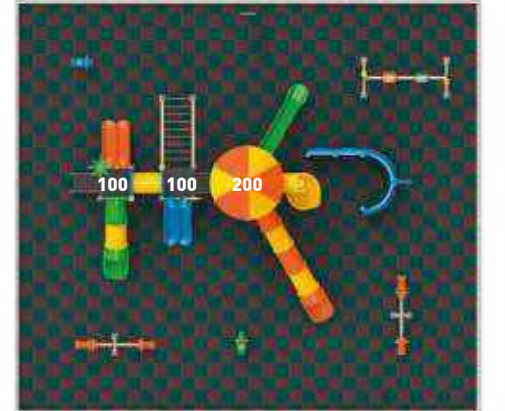

TOKİ SERİSİ
Toki Series

TK1705

ÜRÜN KODU
Product Code
TK1704

YAŞ ARALIĞI
Ages
5-12

DÜŞME YÜKSEKLİĞİ
Fall Height (mm)
1500

OTURMA ALANI
Settle Area (mm)
8250x10650

ÜRÜN ADI
Product Name
Toki Serisi

KAPASİTE
Number of User
37

TEPE YÜKSEKLİĞİ
Hill Height (mm)
5440

GÜVENLİK ALANI
Safety Area (mm)
12250x14650

ÜRÜN KODU
Product Code
TK1705

YAŞ ARALIĞI
Ages
5-12

DÜŞME YÜKSEKLİĞİ
Fall Height (mm)
2000

OTURMA ALANI
Settle Area (mm)
11100x13000

ÜRÜN ADI
Product Name
Toki Serisi

KAPASİTE
Number of User
43

TEPE YÜKSEKLİĞİ
Hill Height (mm)
5940

GÜVENLİK ALANI
Safety Area (mm)
15100x17000

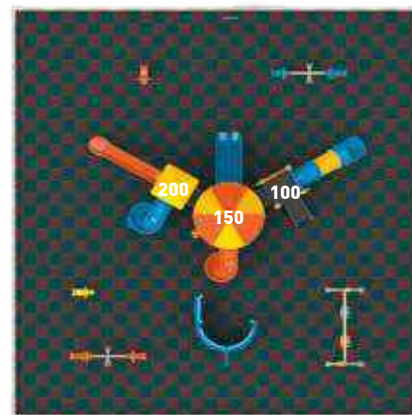

TOKİ SERİSİ
Toki Series

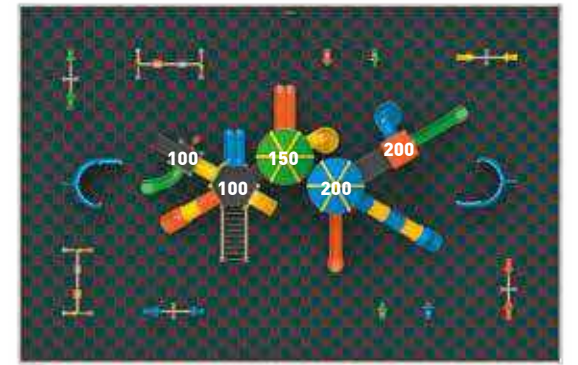

TOKİ SERİSİ
Toki Series

TK1706

TK1707

ÜRÜN KODU
Product Code
TK1706

YAŞ ARALIĞI
Ages
5-12

DÜŞME YÜKSEKLİĞİ
Fall Height (mm)
1500

OTURMA ALANI
Settle Area (mm)
13520x10960

ÜRÜN ADI
Product Name
Toki Serisi

KAPASİTE
Number of User
38

TEPE YÜKSEKLİĞİ
Hill Height (mm)
5490

GÜVENLİK ALANI
Safety Area (mm)
17520x14960

ÜRÜN KODU
Product Code
TK1707

YAŞ ARALIĞI
Ages
5-12

DÜŞME YÜKSEKLİĞİ
Fall Height (mm)
2000

OTURMA ALANI
Settle Area (mm)
25085x20135

ÜRÜN ADI
Product Name
Toki Serisi

KAPASİTE
Number of User
87

TEPE YÜKSEKLİĞİ
Hill Height (mm)
5945

GÜVENLİK ALANI
Safety Area (mm)
29085x24135

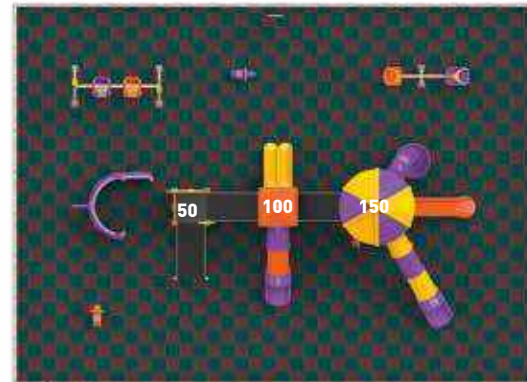

TOKI SERİSİ

Toki Series



TK1708

ÜRÜN KODU
Product Code
TK1708

ÜRÜN ADI
Product Name
Toki Serisi

YAŞ ARALIĞI
Ages
5-12

KAPASİTE
Number of User
48

DÜŞME YÜKSEKLİĞİ
Fall Height (mm)
1500

TEPE YÜKSEKLİĞİ
Hill Height (mm)
5440

OTURMA ALANI
Settle Area (mm)
12410x14610

GÜVENLİK ALANI
Safety Area (mm)
16410x18610

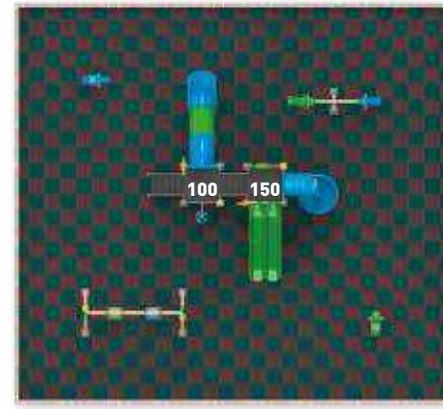

TK1709

TOKİ SERİSİ
Toki Series

ÜRÜN KODU
Product Code
TK1709

YAŞ ARALIĞI
Ages
5-12

DÜŞME YÜKSEKLİĞİ
Fall Height (mm)
1500

OTURMA ALANI
Settle Area (mm)
8700x9500

ÜRÜN ADI
Product Name
Toki Serisi

KAPASİTE
Number of User
26

TEPE YÜKSEKLİĞİ
Hill Height (mm)
3945

GÜVENLİK ALANI
Safety Area (mm)
12700x13500



OYUN ELEMANLARI
Playground Elements



SALINCAK SERİSİ

Swing Series

SALINCAK SERİSİ

Swing Series



SW1801



SW1802



SW1803



SW1805



SW1805-1



SW1806

ÜRÜN KODU Product Code	ÜRÜN ADI Product Name	YAŞ ARALIĞI Ages	KAPASİTE Number of User	DÜŞME YÜKSEKLİĞİ Drop Height (mm)	TEPE YÜKSEKLİĞİ Hill Height (mm)	OTURUM ALANI Seating Area (mm)	GÜVENLİK ALANI Safety Area (mm)
SW1801	Salıncak Serisi / Swing Series	3-12	2	-	2700	1500x3250	4500x6250
SW1802	Salıncak Serisi / Swing Series	3-12	2	-	2700	1500x3250	4500x6250
SW1803	Salıncak Serisi / Swing Series	3-12	4	-	2700	1500x3250	4500x6250
SW1805	Salıncak Serisi / Swing Series	3-12	2	-	2990	1500x2254	4500x5254
SW1805-1	Salıncak Serisi / Swing Series	3-12	3	-	2990	1500x3250	4500x6250
SW1806	Salıncak Serisi / Swing Series	3-12	3	-	2700	1500x5318	4500x8318

SALINCAK SERİSİ

Swing Series



SW1807



SW1808

SALINCAK SERİSİ

Swing Series



SW1814



SW1809



SW1810



SW1815



SW1811



SW1812



SW1816

ÜRÜN KODU	ÜRÜN ADI	YAŞ ARALIĞI	KAPASİTE	DÜŞME YÜKSEKLİĞİ	TEPE YÜKSEKLİĞİ	OTURUM ALANI	GÜVENLİK ALANI
Product Code	Product Name	Ages	Number of User	Drop Height (mm)	Hill Height (mm)	Seating Area (mm)	Safety Area (mm)
SW1807	Salıncak Serisi / Swing Series	3-12	5	-	2700	1500x5318	4500x8318
SW1808	Salıncak Serisi / Swing Series	3-12	4	-	2700	1500x6320	4500x9320
SW1809	Salıncak Serisi / Swing Series	3-12	4	-	2700	1500x6320	4500x9320
SW1810	Salıncak Serisi / Swing Series	3-12	6	-	2700	1500x6320	4500x9320
SW1811	Salıncak Serisi / Swing Series	5-12	9	-	2700	1500x4808	4500x7808
SW1812	Salıncak Serisi / Swing Series	5-12	12	-	2700	1500x5813	4500x8813

ÜRÜN KODU	ÜRÜN ADI	YAŞ ARALIĞI	KAPASİTE	DÜŞME YÜKSEKLİĞİ	TEPE YÜKSEKLİĞİ	OTURUM ALANI	GÜVENLİK ALANI
Product Code	Product Name	Ages	Number of User	Drop Height (mm)	Hill Height (mm)	Seating Area (mm)	Safety Area (mm)
SW1814	Salıncak Serisi / Swing Series	+5	6	-	3610	7350x3070	10350x6070
SW1815	Salıncak Serisi / Swing Series	3-12	5	-	2745	3300x8930	6300x11930
SW1816	Salıncak Serisi / Swing Series	3-12	9	-	2745	8930x8930	11930x11930



TAHTEREVALLI SERİSİ

Seesaw Series

TAHTEREVALLI SERİSİ

Seesaw Series



TS1901

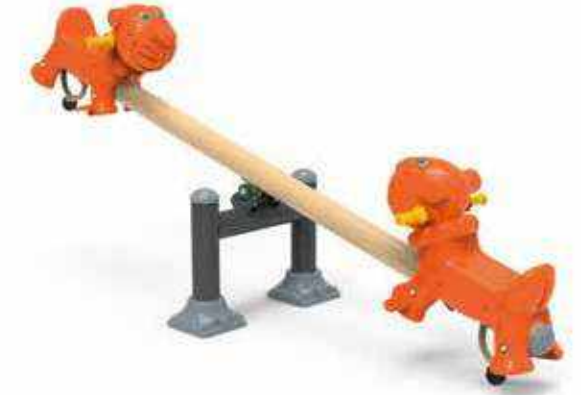

TS1902



TS1903



TS1904



TS1905



TS1906



ÜRÜN KODU Product Code	ÜRÜN ADI Product Name	YAŞ ARALIĞI Ages	KAPASİTE Number of User	DÜŞME YÜKSEKLİĞİ Drop Height (mm)	TEPE YÜKSEKLİĞİ Hill Height (mm)	OTURUM ALANI Seating Area (mm)	GÜVENLİK ALANI Safety Area (mm)
TS1901	Tahterevalli Serisi / Seesaw Series	3-12	2	-	1200	850x2950	3850x5950
TS1902	Tahterevalli Serisi / Seesaw Series	3-12	2	-	1300	850x2950	3850x5950
TS1903	Tahterevalli Serisi / Seesaw Series	3-12	2	-	1300	850x2950	3850x5950
TS1904	Tahterevalli Serisi / Seesaw Series	3-12	4	-	1200	1500x2950	4500x5950
TS1905	Tahterevalli Serisi / Seesaw Series	3-12	3	-	1100	310x2200	3310x5200
TS1906	Tahterevalli Serisi / Seesaw Series	3-12	3	-	970	310x2200	3310x5200

TAHTEREVALLI SERİSİ Seesaw Series



TS1908



TS1909



TS1910

ÜRÜN KODU Product Code	ÜRÜN ADI Product Name	YAŞ ARALIĞI Ages	KAPASİTE Number of User	DÜŞME YÜKSEKLİĞİ Drop Height (mm)	TEPE YÜKSEKLİĞİ Hill Height (mm)	OTURUM ALANI Seating Area (mm)	GÜVENLİK ALANI Safety Area (mm)
TS1908	Tahterevalli Serisi / Seesaw Series	3-12	4	-	800	800x2875	3900x5875
TS1909	Tahterevalli Serisi / Seesaw Series	3-12	2	-	1330	1360x3090	4360x6090
TS1910	Tahterevalli Serisi / Seesaw Series	3-12	2	-	1430	1360x3090	4360x6090



ZIP ZIP SERİSİ Pogo Stick Series

ZIP ZIP SERİSİ

Pogo Stick Series



ZP2001



ZP2002

ZIP ZIP SERİSİ

Pogo Stick Series



ZP2007



ZP2008



ZP2003



ZP2004



ZP2009



ZP2010



ZP2005



ZP2006

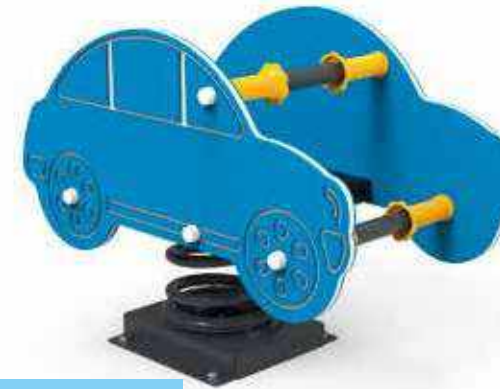

ZP2013



ZP2014

ÜRÜN KODU	ÜRÜN ADI	YAŞ ARALIĞI	KAPASİTE	DÜŞME YÜKSEKLİĞİ	TEPE YÜKSEKLİĞİ	OTURUM ALANI	GÜVENLİK ALANI
Product Code	Product Name	Ages	Number of User	Drop Height (mm)	Hill Height (mm)	Seating Area (mm)	Safety Area (mm)
ZP2001	Zip Zip Serisi / Pogo Stick Series	3-12	1	-	800	500x840	3500x3840
ZP2002	Zip Zip Serisi / Pogo Stick Series	3-12	1	-	845	500x912	3500x3912
ZP2003	Zip Zip Serisi / Pogo Stick Series	3-12	1	-	1050	400x950	3500x3950
ZP2004	Zip Zip Serisi / Pogo Stick Series	3-12	1	-	1000	400x600	3500x3600
ZP2005	Zip Zip Serisi / Pogo Stick Series	3-12	1	-	1100	360x1560	3360x4560
ZP2006	Zip Zip Serisi / Pogo Stick Series	3-12	1	-	770	310x860	3310x3860

ÜRÜN KODU	ÜRÜN ADI	YAŞ ARALIĞI	KAPASİTE	DÜŞME YÜKSEKLİĞİ	TEPE YÜKSEKLİĞİ	OTURUM ALANI	GÜVENLİK ALANI
Product Code	Product Name	Ages	Number of User	Drop Height (mm)	Hill Height (mm)	Seating Area (mm)	Safety Area (mm)
ZP2007	Zip Zip Serisi / Pogo Stick Series	3-12	1	-	665	310x780	3310x3780
ZP2008	Zip Zip Serisi / Pogo Stick Series	3-12	1	-	660	310x860	3310x3860
ZP2009	Zip Zip Serisi / Pogo Stick Series	3-12	1	-	630	445x770	3445x3770
ZP2010	Zip Zip Serisi / Pogo Stick Series	3-12	1	-	670	445x560	3445x3560
ZP2013	Zip Zip Serisi / Pogo Stick Series	3-12	1	-	620	445x780	3445x3780
ZP2014	Zip Zip Serisi / Pogo Stick Series	3-12	1	-	620	445x590	3445x3590

ZIP ZIP SERİSİ

Pogo Stick Series



ZP2017



ZP2018

ZIP ZIP SERİSİ

Pogo Stick Series



ZP2024



ZP2025



ZP2020



ZP2021



ZP2026



ZP2022



ZP2023

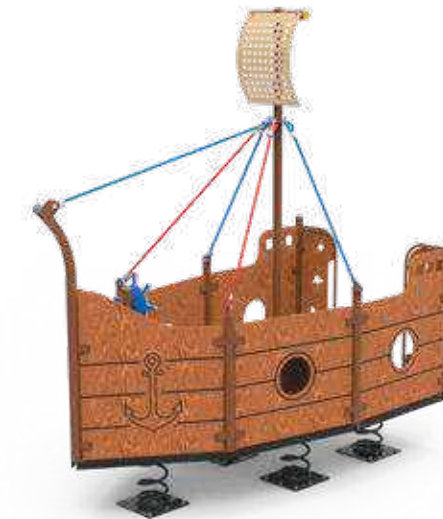

ZP2027

ÜRÜN KODU	ÜRÜN ADI	YAŞ ARALIĞI	KAPASİTE	DÜŞME YÜKSEKLİĞİ	TEPE YÜKSEKLİĞİ	OTURUM ALANI	GÜVENLİK ALANI
Product Code	Product Name	Ages	Number of User	Drop Height (mm)	Hill Height (mm)	Seating Area (mm)	Safety Area (mm)
ZP2017	Zip Zip Serisi / Pogo Stick Series	3-12	2	-	360	600x1000	3600x4000
ZP2018	Zip Zip Serisi / Pogo Stick Series	3-12	3	-	1550	600x2590	3600x5590
ZP2020	Zip Zip Serisi / Pogo Stick Series	3-12	6	-	1900	1350x2130	4350x5130
ZP2021	Zip Zip Serisi / Pogo Stick Series	3-12	1	-	740	310x930	3310x3930
ZP2022	Zip Zip Serisi / Pogo Stick Series	3-12	1	-	750	310x900	3310x3900
ZP2023	Zip Zip Serisi / Pogo Stick Series	3-12	1	-	770	310x1050	3310x4050

ÜRÜN KODU	ÜRÜN ADI	YAŞ ARALIĞI	KAPASİTE	DÜŞME YÜKSEKLİĞİ	TEPE YÜKSEKLİĞİ	OTURUM ALANI	GÜVENLİK ALANI
Product Code	Product Name	Ages	Number of User	Drop Height (mm)	Hill Height (mm)	Seating Area (mm)	Safety Area (mm)
ZP2024	Zip Zip Serisi / Pogo Stick Series	3-12	1	-	660	480x550	3480x3550
ZP2025	Zip Zip Serisi / Pogo Stick Series	3-12	6	-	880	1840x1840	4840x4840
ZP2026	Zip Zip Serisi / Pogo Stick Series	3-12	6	-	443	1500x1500	4500x4500
ZP2027	Zip Zip Serisi / Pogo Stick Series	3-12	8	-	3160	1500x3040	4500x7040



YENİ NESİL SERİSİ

New Generation Series

YENİ NESİL SERİSİ

New Generation Series



YN2101



YN2103



YN2107



YN2108



YN2109

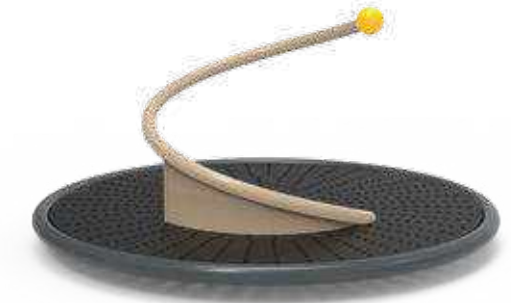

YN2110

ÜRÜN KODU	ÜRÜN ADI	YAŞ ARALIĞI	KAPASİTE	DÜŞME YÜKSEKLİĞİ	TEPE YÜKSEKLİĞİ	OTURUM ALANI	GÜVENLİK ALANI
Product Code	Product Name	Ages	Number of User	Drop Height (mm)	Hill Height (mm)	Seating Area (mm)	Safety Area (mm)
YN2101	Yeni Nesil Serisi / New Generation Series	3-12	1	-	770	500x585	3500x3585
YN2103	Yeni Nesil Serisi / New Generation Series	3-12	2	-	966	630x2736	3630x5736
YN2107	Yeni Nesil Serisi / New Generation Series	5-12	2	-	2400	350x2875	3350x5875
YN2108	Yeni Nesil Serisi / New Generation Series	5-12	4	-	2540	2990x4450	5990x7450
YN2109	Yeni Nesil Serisi / New Generation Series	5-12	4	-	2545	2970x2970	5970x5970
YN2110	Yeni Nesil Serisi / New Generation Series	5-12	4	-	630	1300x1300	4300x4300

YENİ NESİL SERİSİ
New Generation Series



YN2111



YN2112



YN2113



YN2114



YN2115



YN2116



YN2117

ÜRÜN KODU Product Code	ÜRÜN ADI Product Name	YAŞ ARALIĞI Ages	KAPASİTE Number of User	DÜŞME YÜKSEKLİĞİ Drop Height (mm)	TEPE YÜKSEKLİĞİ Hill Height (mm)	OTURUM ALANI Seating Area (mm)	GÜVENLİK ALANI Safety Area (mm)
YN2111	Yeni Nesil Serisi / New Generation Series	5-12	4	-	1150	1300x1300	4300x4300
YN2112	Yeni Nesil Serisi / New Generation Series	5-12	4	-	1150	1300x1300	4300x4300
YN2113	Yeni Nesil Serisi / New Generation Series	5-12	4	-	790	1190x1190	4190x4190
YN2114	Yeni Nesil Serisi / New Generation Series	5-12	4	-	990	1860x1860	4860x4860
YN2115	Yeni Nesil Serisi / New Generation Series	5-12	2	-	1590	600x600	3600x3600
YN2116	Yeni Nesil Serisi / New Generation Series	5-12	4	-	2516	1790x1790	4790x4790
YN2117	Yeni Nesil Serisi / New Generation Series	5-12	6	-	2460	2120x4630	5120x7630



DÖNME DOLAP SERİSİ
Ferris Wheel Series

DÖNME DOLAP SERİSİ

Ferris Wheel Series



DD2201



DD2202

DÖNME DOLAP SERİSİ

Ferris Wheel Series



DD2205



DD2205-1



DD2203



DD2203-1



DD2206



DD2207



DD2204



DD2204-1



DD2208



DD2210

ÜRÜN KODU	ÜRÜN ADI	YAŞ ARALIĞI	KAPASİTE	DÜŞME YÜKSEKLİĞİ	TEPE YÜKSEKLİĞİ	OTURUM ALANI	GÜVENLİK ALANI
Product Code	Product Name	Ages	Number of User	Drop Height (mm)	Hill Height (mm)	Seating Area (mm)	Safety Area (mm)
DD2201	Dönme Dolap Serisi / Ferris Wheel Series	3-12	1	-	620	620x620	3620x3620
DD2202	Dönme Dolap Serisi / Ferris Wheel Series	3-12	1	-	1430	950x960	3950x3960
DD2203	Dönme Dolap Serisi / Ferris Wheel Series	3-12	4	-	1040	1300x1300	4300x4300
DD2203-1	Dönme Dolap Serisi / Ferris Wheel Series	3-12	4	-	880	1200x1200	4200x4200
DD2204	Dönme Dolap Serisi / Ferris Wheel Series	3-12	4	-	870	1700x1700	4700x4700
DD2204-1	Dönme Dolap Serisi / Ferris Wheel Series	3-12	4	-	690	1220x1220	4220x4220

ÜRÜN KODU	ÜRÜN ADI	YAŞ ARALIĞI	KAPASİTE	DÜŞME YÜKSEKLİĞİ	TEPE YÜKSEKLİĞİ	OTURUM ALANI	GÜVENLİK ALANI
Product Code	Product Name	Ages	Number of User	Drop Height (mm)	Hill Height (mm)	Seating Area (mm)	Safety Area (mm)
DD2205	Dönme Dolap Serisi / Ferris Wheel Series	3-12	4	-	1710	2000x2000	5000x5000
DD2205-1	Dönme Dolap Serisi / Ferris Wheel Series	3-12	3	-	1140	1650x1650	4650x4650
DD2206	Dönme Dolap Serisi / Ferris Wheel Series	3-12	5	-	690	1390x1390	4390x4390
DD2207	Dönme Dolap Serisi / Ferris Wheel Series	5-12	4	-	985	1740x1790	4740x4790
DD2208	Dönme Dolap Serisi / Ferris Wheel Series	5-12	4	-	2210	1980x2005	4980x5005
DD22010	Dönme Dolap Serisi / Ferris Wheel Series	3-12	6	-	950	2300x2300	5300x5300

DÖNME DOLAP SERİSİ

Ferris Wheel Series



DD2211



DD2212



DD2213



DD2214

ÜRÜN KODU	ÜRÜN ADI	YAŞ ARALIĞI	KAPASİTE	DÜŞME YÜKSEKLİĞİ	TEPE YÜKSEKLİĞİ	OTURUM ALANI	GÜVENLİK ALANI
Product Code	Product Name	Ages	Number of User	Drop Height (mm)	Hill Height (mm)	Seating Area (mm)	Safety Area (mm)
DD2211	Dönme Dolap Serisi / Ferris Wheel Series	5-12	6	-	2240	1490x1490	4490x4490
DD2212	Dönme Dolap Serisi / Ferris Wheel Series	5-12	6	-	2620	2340x2340	5340x5340
DD2213	Dönme Dolap Serisi / Ferris Wheel Series	5-12	12	-	2580	3095x3095	6095x6095
DD2214	Dönme Dolap Serisi / Ferris Wheel Series	5-12	8	-	2900	2510x2510	5510x5510



FANTASTİK SERİSİ
Fantastic Series

FANTASTİK SERİSİ

Fantastic Series



FT2301



FT2302

FANTASTİK SERİSİ

Fantastic Series



FT2307



FT2308



FT2303



FT2304



FT2309



FT2310



FT2305



FT2306



FT2311



FT2312

ÜRÜN KODU	ÜRÜN ADI	YAŞ ARALIĞI	KAPASİTE	DÜŞME YÜKSEKLİĞİ	TEPE YÜKSEKLİĞİ	OTURUM ALANI	GÜVENLİK ALANI
Product Code	Product Name	Ages	Number of User	Drop Height (mm)	Hill Height (mm)	Seating Area (mm)	Safety Area (mm)
FT2301	Fantastik Serisi / Fantastic Series	5-12	2	-	3330	4586x490	7586x3490
FT2302	Fantastik Serisi / Fantastic Series	5-12	2	-	1520	4270x418	7270x3418
FT2303	Fantastik Serisi / Fantastic Series	5-12	5	-	3430	4450x4660	7450x7660
FT2304	Fantastik Serisi / Fantastic Series	5-12	3	-	3600	4800x5570	7800x8570
FT2305	Fantastik Serisi / Fantastic Series	5-12	2	-	2510	4820x2940	7820x5940
FT2306	Fantastik Serisi / Fantastic Series	5-12	2	-	2700	3000x1500	7000x4500

ÜRÜN KODU	ÜRÜN ADI	YAŞ ARALIĞI	KAPASİTE	DÜŞME YÜKSEKLİĞİ	TEPE YÜKSEKLİĞİ	OTURUM ALANI	GÜVENLİK ALANI
Product Code	Product Name	Ages	Number of User	Drop Height (mm)	Hill Height (mm)	Seating Area (mm)	Safety Area (mm)
FT2307	Fantastik Serisi / Fantastic Series	5-12	5	-	2700	3390x1500	6390x4500
FT2308	Fantastik Serisi / Fantastic Series	5-12	5	-	2700	3140x1500	6140x4500
FT2309	Fantastik Serisi / Fantastic Series	5-12	8	-	2420	2750x1500	5750x4500
FT2310	Fantastik Serisi / Fantastic Series	5-12	3	-	1370	1430x1810	4430x4810
FT2311	Fantastik Serisi / Fantastic Series	5-12	3	-	1370	1430x1810	4430x4810
FT2312	Fantastik Serisi / Fantastic Series	5-12	8	-	2050	3745x5020	6745x8020

FANTASTİK SERİSİ
Fantastic Series

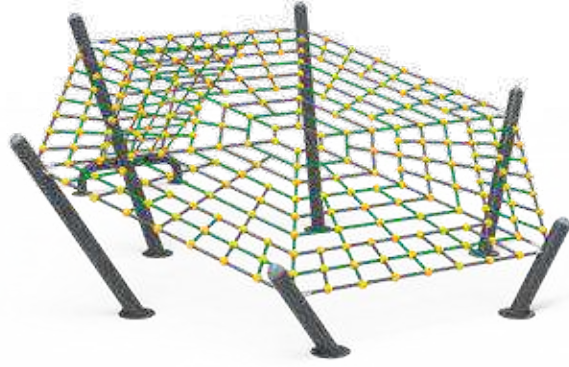

FT2313

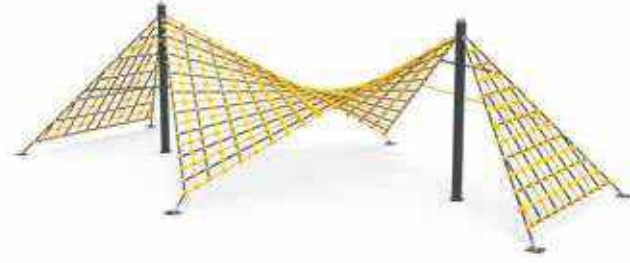

FT2314

FANTASTİK SERİSİ
Fantastic Series



FT2317-1



FT2321

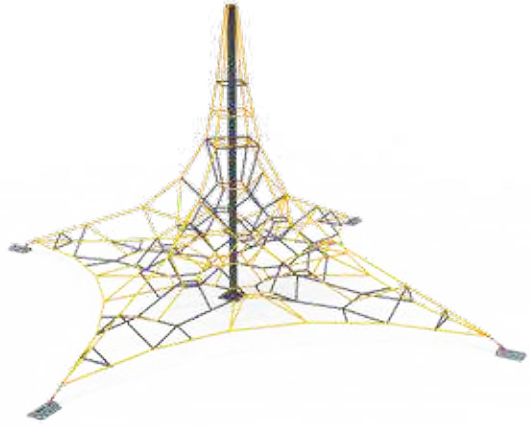

FT2315

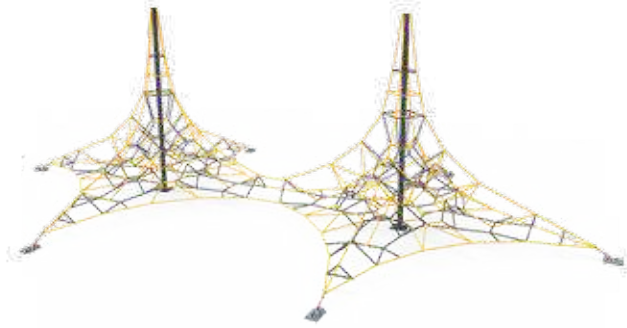

FT2315-1



FT2319



FT2320



FT2316



FT2317



FT2318

ÜRÜN KODU Product Code	ÜRÜN ADI Product Name	YAŞ ARALIĞI Ages	KAPASİTE Number of User	DÜŞME YÜKSEKLİĞİ Drop Height (mm)	TEPE YÜKSEKLİĞİ Hill Height (mm)	OTURUM ALANI Seating Area (mm)	GÜVENLİK ALANI Safety Area (mm)
FT2313	Fantastik Serisi / Fantastic Series	5-12	6	-	1800	4120x4330	7120x7330
FT2314	Fantastik Serisi / Fantastic Series	5-12	6	-	2000	7500x4500	10500x7500
FT2315	Fantastik Serisi / Fantastic Series	5-12	32	-	4000	5900x5900	8900x8900
FT2315-1	Fantastik Serisi / Fantastic Series	5-12	48	-	4000	8300x14200	11300x17200
FT2316	Fantastik Serisi / Fantastic Series	5-12	10	-	2000	6230x7100	9230x10100
FT2317	Fantastik Serisi / Fantastic Series	5-12	10	-	2350	4790x4790	7790x7790

ÜRÜN KODU Product Code	ÜRÜN ADI Product Name	YAŞ ARALIĞI Ages	KAPASİTE Number of User	DÜŞME YÜKSEKLİĞİ Drop Height (mm)	TEPE YÜKSEKLİĞİ Hill Height (mm)	OTURUM ALANI Seating Area (mm)	GÜVENLİK ALANI Safety Area (mm)
FT2317-1	Fantastik Serisi / Fantastic Series	5-12	8	-	2350	3630x4180	6630x7180
FT2318	Fantastik Serisi / Fantastic Series	5-12	15	1000	2580	10000x8500	13000x11500
FT2319	Fantastik Serisi / Fantastic Series	5-12	4	-	1000	1800x3000	4800x6000
FT2320	Fantastik Serisi / Fantastic Series	5-12	1	-	1750	1650x1250	4650x4250
FT2321	Fantastik Serisi / Fantastic Series	5-12	2	-	1960	2200x4770	5200x7770

FANTASTİK SERİSİ

Fantastic Series



FT2322



FT2323

FANTASTİK SERİSİ

Fantastic Series



FT2328



FT2329



FT2325

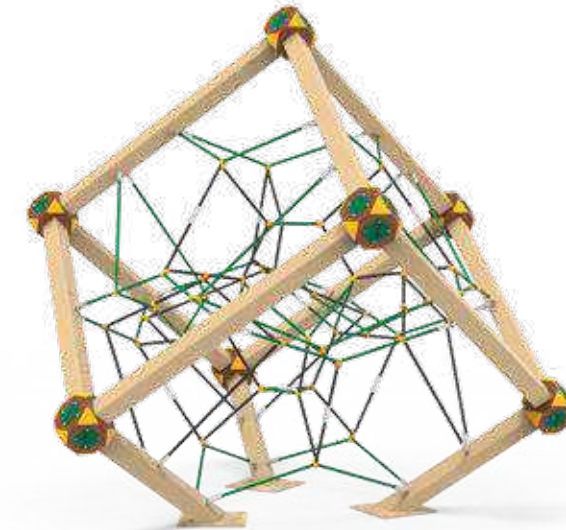

FT2330



FT2326



FT2327

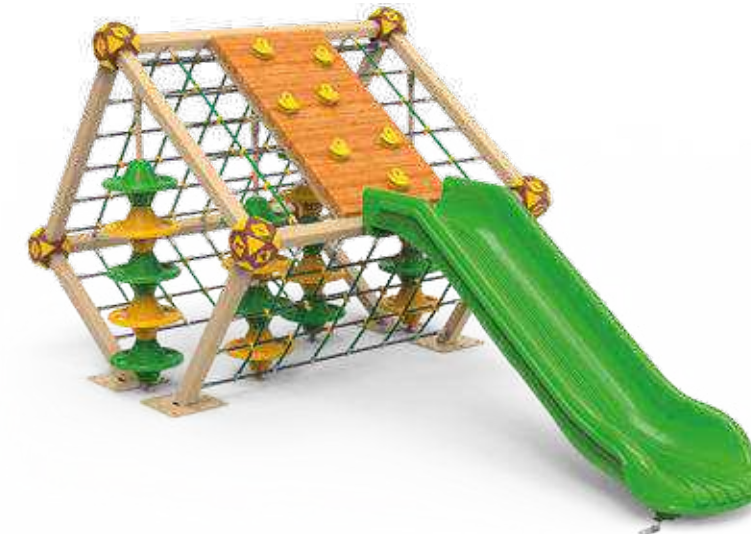

FT2331

ÜRÜN KODU Product Code	ÜRÜN ADI Product Name	YAŞ ARALIĞI Ages	KAPASİTE Number of User	DÜŞME YÜKSEKLİĞİ Drop Height (mm)	TEPE YÜKSEKLİĞİ Hill Height (mm)	OTURUM ALANI Seating Area (mm)	GÜVENLİK ALANI Safety Area (mm)
FT2322	Fantastik Serisi / Fantastic Series	5-12	6	-	2370	3860x3260	6860x6260
FT2323	Fantastik Serisi / Fantastic Series	5-12	9	-	2370	3860x4270	6860x7270
FT2325	Fantastik Serisi / Fantastic Series	5-12	5	1000	3000	18810x5030	22810x9030
FT2326	Fantastik Serisi / Fantastic Series	5-12	26	-	2380	8970x10200	11970x13200
FT2327	Fantastik Serisi / Fantastic Series	5-12	30	-	2380	7250x7250	10250x10250

ÜRÜN KODU Product Code	ÜRÜN ADI Product Name	YAŞ ARALIĞI Ages	KAPASİTE Number of User	DÜŞME YÜKSEKLİĞİ Drop Height (mm)	TEPE YÜKSEKLİĞİ Hill Height (mm)	OTURUM ALANI Seating Area (mm)	GÜVENLİK ALANI Safety Area (mm)
FT2328	Fantastik Serisi / Fantastic Series	5-12	5	-	2140	2690x3100	5690x6100
FT2329	Fantastik Serisi / Fantastic Series	5-12	6	-	2500	2170x2170	5170x5170
FT2330	Fantastik Serisi / Fantastic Series	5-12	4	-	2680	2670x3050	5670x6050
FT2331	Fantastik Serisi / Fantastic Series	5-12	8	1000	1990	2295x4520	5295x7520

FANTASTİK SERİSİ
Fantastic Series

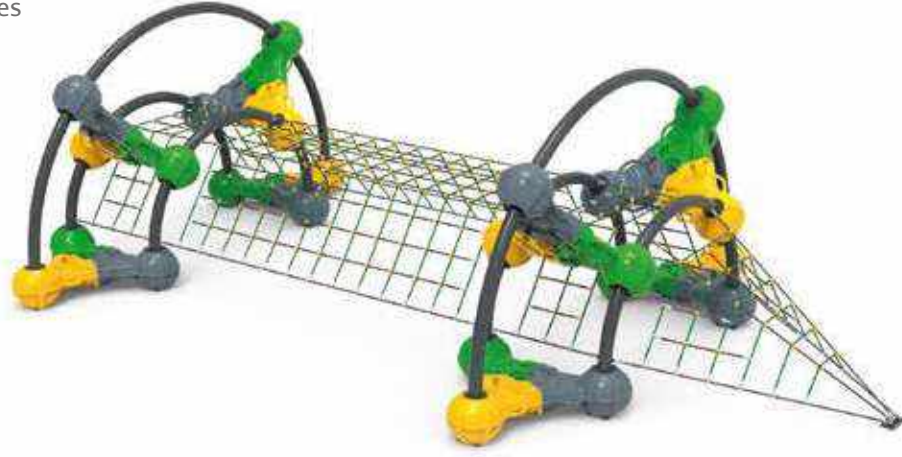

FT2332

FANTASTİK SERİSİ
Fantastic Series



FT2335



FT2336



FT2333



FT2337

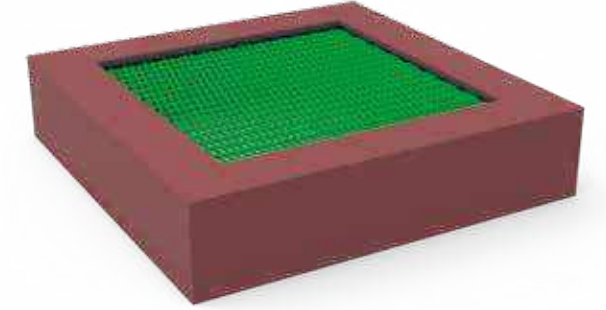

FT2338

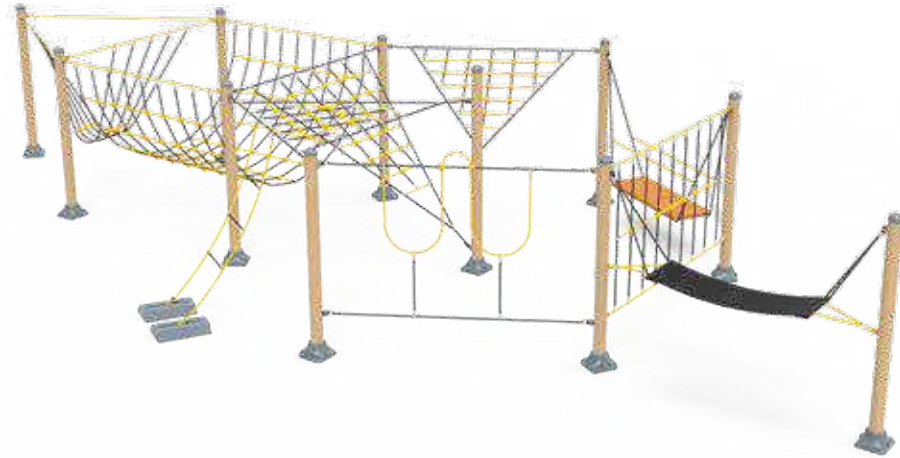

FT2334

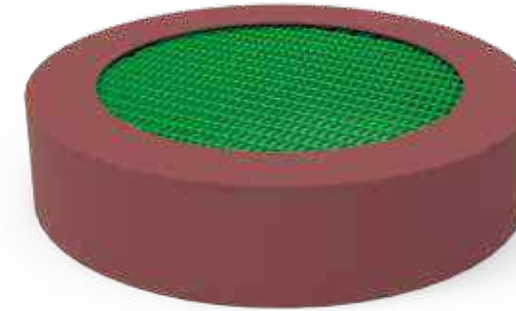

FT2339



FT2340

ÜRÜN KODU Product Code	ÜRÜN ADI Product Name	YAŞ ARALIĞI Ages	KAPASİTE Number of User	DÜŞME YÜKSEKLİĞİ Drop Height (mm)	TEPE YÜKSEKLİĞİ Hill Height (mm)	OTURUM ALANI Seating Area (mm)	GÜVENLİK ALANI Safety Area (mm)
FT2332	Fantastik Serisi / Fantastic Series	5-12	16	-	2500	8550x4780	11550x7780
FT2333	Fantastik Serisi / Fantastic Series	5-12	10	-	1400	5770x7600	8770x10600
FT2334	Fantastik Serisi / Fantastic Series	5-12	16	-	2000	4080x3530	7080x6530

ÜRÜN KODU Product Code	ÜRÜN ADI Product Name	YAŞ ARALIĞI Ages	KAPASİTE Number of User	DÜŞME YÜKSEKLİĞİ Drop Height (mm)	TEPE YÜKSEKLİĞİ Hill Height (mm)	OTURUM ALANI Seating Area (mm)	GÜVENLİK ALANI Safety Area (mm)
FT2335	Fantastik Serisi / Fantastic Series	5-12	2	1000	2040	3080x775	6080x3775
FT2336	Fantastik Serisi / Fantastic Series	5-12	2	1500	2540	3770x815	6770x3815
FT2337	Fantastik Serisi / Fantastic Series	5-12	2	1500	2500	3530x625	6530x3625
FT2338	Fantastik Serisi / Fantastic Series	5-12	1	-	-	1800x1800	4800x4800
FT2339	Fantastik Serisi / Fantastic Series	5-12	1	-	-	1800	4800
FT2340	Fantastik Serisi / Fantastic Series	5-12	10	-	-	8080x4790	11080x7790



ÖZGÜR SERİSİ
ÖZEL EKİPMANLARI
Independent Series Private Elements

ÖZGÜR SERİSİ
ÖZEL EKİPMANLARI
Independent Series
Private Elements



SW1804



SW1804-1



SW1813

ÖZGÜR SERİSİ
ÖZEL EKİPMANLARI
Independent Series
Private Elements



SW1813-1



TS1907



NPE3801

ÜRÜN KODU Product Code	ÜRÜN ADI Product Name	YAŞ ARALIĞI Ages	KAPASİTE Number of User	DÜŞME YÜKSEKLİĞİ Drop Height (mm)	TEPE YÜKSEKLİĞİ Hill Height (mm)	OTURUM ALANI Seating Area (mm)	GÜVENLİK ALANI Safety Area (mm)
SW1804	Özgür Serisi Özel Ekipmanları / Independent Series Private Elements	5-12	2	-	2845	1500x3250	4500x6250
SW1804-1	Özgür Serisi Özel Ekipmanları / Independent Series Private Elements	5-12	2	-	2845	1500x3250	4500x6250
SW1813	Özgür Serisi Özel Ekipmanları / Independent Series Private Elements	5-12	1	-	2320	2000x3260	5000x6260

ÜRÜN KODU Product Code	ÜRÜN ADI Product Name	YAŞ ARALIĞI Ages	KAPASİTE Number of User	DÜŞME YÜKSEKLİĞİ Drop Height (mm)	TEPE YÜKSEKLİĞİ Hill Height (mm)	OTURUM ALANI Seating Area (mm)	GÜVENLİK ALANI Safety Area (mm)
SW1813-1	Özgür Serisi Özel Ekipmanları / Independent Series Private Elements	5-12	1	-	2320	2000x3260	5000x6260
TS1907	Özgür Serisi Özel Ekipmanları / Independent Series Private Elements	5-12	2	-	1680	850x3160	3850x6160
NPE3801	Özgür Serisi Özel Ekipmanları / Independent Series Private Elements	5-12	2	-	1000	950x2900	3950x5900

ÖZGÜR SERİSİ
ÖZEL EKİPMANLARI
Independent Series
Private Elements



♿ NPE3802



♿ NPE3803



♿ NPE3804

ÜRÜN KODU Product Code	ÜRÜN ADI Product Name	YAŞ ARALIĞI Ages	KAPASİTE Number of User	DÜŞME YÜKSEKLİĞİ Drop Height (mm)	TEPE YÜKSEKLİĞİ Hill Height (mm)	OTURUM ALANI Seating Area (mm)	GÜVENLİK ALANI Safety Area (mm)
NPE3802	Özgür Serisi Özel Ekipmanları / Independent Series Private Elements	5-12	3	-	1180	3500x3500	6500x6500
NPE3803	Özgür Serisi Özel Ekipmanları / Independent Series Private Elements	5-12	3	-	1250	2000x2800	5000x5800
NPE3804	Özgür Serisi Özel Ekipmanları / Independent Series Private Elements	5-12	1	-	1130	1550x1700	4550x4700

ÖZGÜR SERİSİ
ÖZEL EKİPMANLARI
Independent Series
Private Elements



♿ NPE3805



♿ NPE3806



ÜRÜN KODU Product Code	ÜRÜN ADI Product Name	YAŞ ARALIĞI Ages	KAPASİTE Number of User	DÜŞME YÜKSEKLİĞİ Drop Height (mm)	TEPE YÜKSEKLİĞİ Hill Height (mm)	OTURUM ALANI Seating Area (mm)	GÜVENLİK ALANI Safety Area (mm)
NPE3805	Özgür Serisi Özel Ekipmanları / Independent Series Private Elements	5-12	2	-	2845	1500x3250	4500x6250
NPE3806	Özgür Serisi Özel Ekipmanları / Independent Series Private Elements	5-12	3	-	1250	800x980	3800x3980



FİTNESS PARK SERİSİ

Fitness Park Series

FİTNESS PARK SERİSİ

Fitness Park Series



FP2405



FP2406

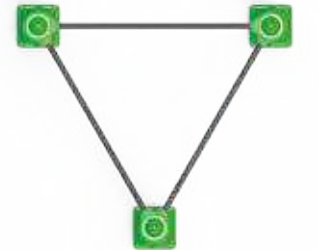

FP2407

ÜRÜN KODU Product Code	ÜRÜN ADI Product Name	YAŞ ARALIĞI Ages	KAPASİTE Number of User	DÜŞME YÜKSEKLİĞİ Drop Height (mm)	TEPE YÜKSEKLİĞİ Hill Height (mm)	OTURUM ALANI Seating Area (mm)	GÜVENLİK ALANI Safety Area (mm)
FP2405	Fitness Park Serisi / Fitness Park Series	+14	1	2500	2640	250x1550	3250x4550
FP2406	Fitness Park Serisi / Fitness Park Series	+14	2	2400	2640	250x2900	3250x5900
FP2407	Fitness Park Serisi / Fitness Park Series	+14	3	2300	2640	1265x1550	4265x4550

FİTNESS PARK SERİSİ

Fitness Park Series

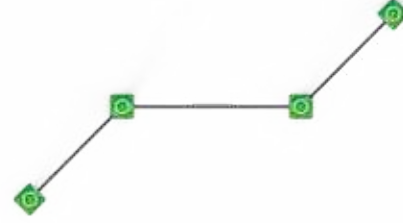

FP2408

FİTNESS PARK SERİSİ

Fitness Park Series

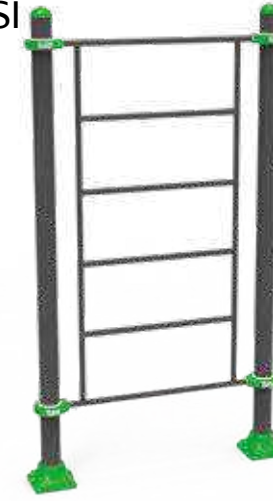

FP2411

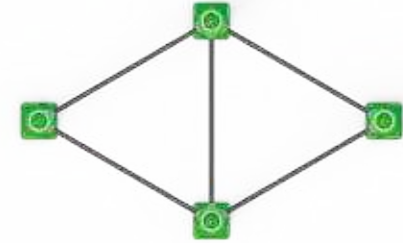

FP2409



FP2412

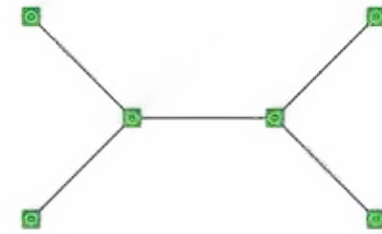

FP2410



FP2413

ÜRÜN KODU Product Code	ÜRÜN ADI Product Name	YAŞ ARALIĞI Ages	KAPASİTE Number of User	DÜŞME YÜKSEKLİĞİ Drop Height (mm)	TEPE YÜKSEKLİĞİ Hill Height (mm)	OTURUM ALANI Seating Area (mm)	GÜVENLİK ALANI Safety Area (mm)
FP2408	Fitness Park Serisi / Fitness Park Series	+14	4	1800	2640	1500x4190	4500x7190
FP2409	Fitness Park Serisi / Fitness Park Series	+14	5	2300	2640	1550x2520	4550x5520
FP2410	Fitness Park Serisi / Fitness Park Series	+14	6	2200	2640	2820x4670	5820x7670

ÜRÜN KODU Product Code	ÜRÜN ADI Product Name	YAŞ ARALIĞI Ages	KAPASİTE Number of User	DÜŞME YÜKSEKLİĞİ Drop Height (mm)	TEPE YÜKSEKLİĞİ Hill Height (mm)	OTURUM ALANI Seating Area (mm)	GÜVENLİK ALANI Safety Area (mm)
FP2411	Fitness Park Serisi / Fitness Park Series	+14	2	2450	2640	250x1550	3250x4550
FP2412	Fitness Park Serisi / Fitness Park Series	+14	3	2460	2640	250x2900	3250x5900
FP2413	Fitness Park Serisi / Fitness Park Series	+14	3	1300	1540	250x4240	3250x7240

FİTNESS PARK SERİSİ

Fitness Park Series



FP2414

FİTNESS PARK SERİSİ

Fitness Park Series



FP2417



FP2415



FP2418



FP2416

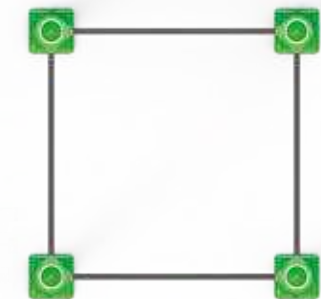

FP2419

ÜRÜN KODU Product Code	ÜRÜN ADI Product Name	YAŞ ARALIĞI Ages	KAPASİTE Number of User	DÜŞME YÜKSEKLİĞİ Drop Height (mm)	TEPE YÜKSEKLİĞİ Hill Height (mm)	OTURUM ALANI Seating Area (mm)	GÜVENLİK ALANI Safety Area (mm)
FP2414	Fitness Park Serisi / Fitness Park Series	+14	1	1300	1540	850x2050	3850x5050
FP2415	Fitness Park Serisi / Fitness Park Series	+14	2	1300	1540	850x3400	3850x6400
FP2416	Fitness Park Serisi / Fitness Park Series	+14	1	300	440	850x1650	3850x4650

ÜRÜN KODU Product Code	ÜRÜN ADI Product Name	YAŞ ARALIĞI Ages	KAPASİTE Number of User	DÜŞME YÜKSEKLİĞİ Drop Height (mm)	TEPE YÜKSEKLİĞİ Hill Height (mm)	OTURUM ALANI Seating Area (mm)	GÜVENLİK ALANI Safety Area (mm)
FP2417	Fitness Park Serisi / Fitness Park Series	+14	1	1050	1540	850x1430	3850x4430
FP2418	Fitness Park Serisi / Fitness Park Series	+14	3	900	1240	850x4540	3850x7540
FP2419	Fitness Park Serisi / Fitness Park Series	+14	5	2450	2640	1550x1550	4550x4550

FİTNESS PARK SERİSİ

Fitness Park Series

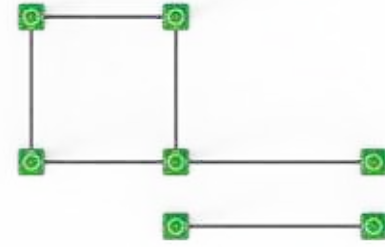

FP2420

FİTNESS PARK SERİSİ

Fitness Park Series

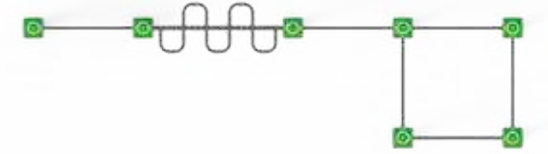
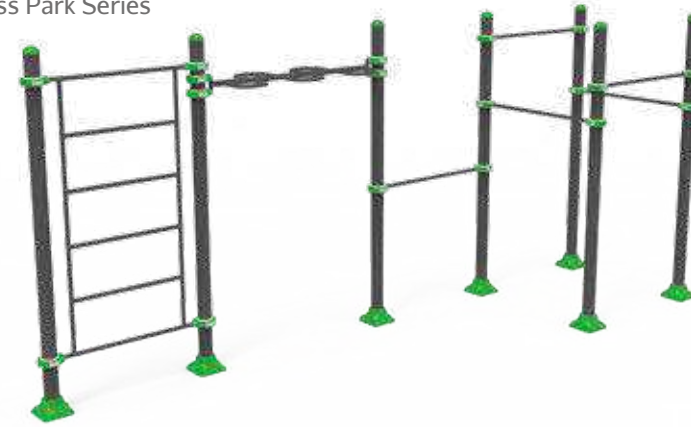

FP2423

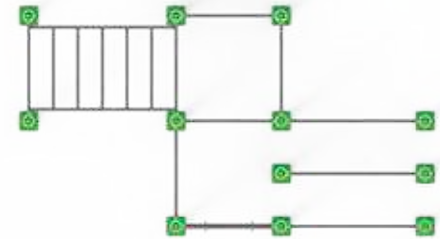

FP2421

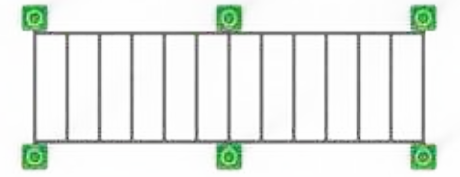

FP2424

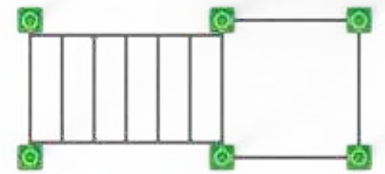

FP2422

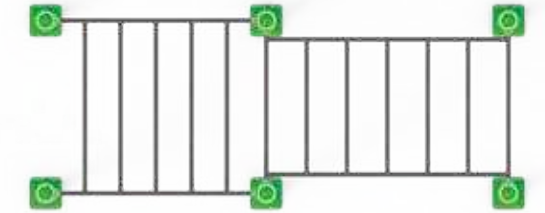

FP2425

ÜRÜN KODU Product Code	ÜRÜN ADI Product Name	YAŞ ARALIĞI Ages	KAPASİTE Number of User	DÜŞME YÜKSEKLİĞİ Drop Height (mm)	TEPE YÜKSEKLİĞİ Hill Height (mm)	OTURUM ALANI Seating Area (mm)	GÜVENLİK ALANI Safety Area (mm)
FP2420	Fitness Park Serisi / Fitness Park Series	+14	6	2400	2640	2400x3400	5400x6400
FP2421	Fitness Park Serisi / Fitness Park Series	+14	10	2100	2640	2960x5360	5960x8360
FP2422	Fitness Park Serisi / Fitness Park Series	+14	6	2450	2640	1550x3440	4550x6440

ÜRÜN KODU Product Code	ÜRÜN ADI Product Name	YAŞ ARALIĞI Ages	KAPASİTE Number of User	DÜŞME YÜKSEKLİĞİ Drop Height (mm)	TEPE YÜKSEKLİĞİ Hill Height (mm)	OTURUM ALANI Seating Area (mm)	GÜVENLİK ALANI Safety Area (mm)
FP2423	Fitness Park Serisi / Fitness Park Series	+14	9	2400	2640	1850x6080	4850x9080
FP2424	Fitness Park Serisi / Fitness Park Series	+14	4	2400	2640	1550x3980	4550x6980
FP2425	Fitness Park Serisi / Fitness Park Series	+14	4	2310	2640	1560x3810	4560x6810

FİTNESS PARK SERİSİ

Fitness Park Series

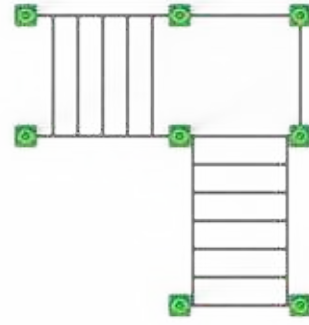
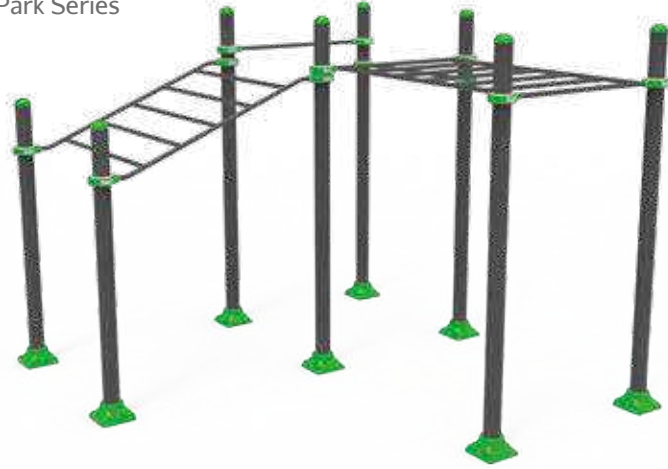

FP2426

FİTNESS PARK SERİSİ

Fitness Park Series

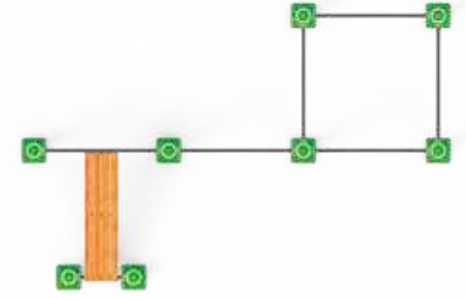

FP2429

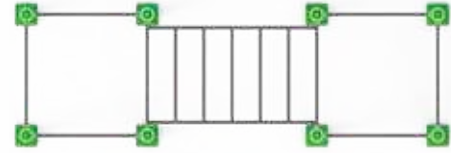

FP2427

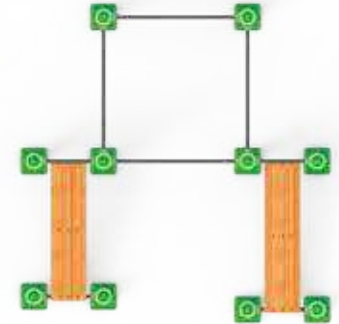

FP2430

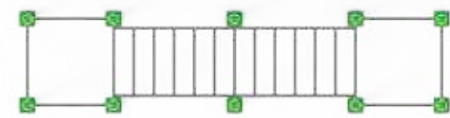

FP2428

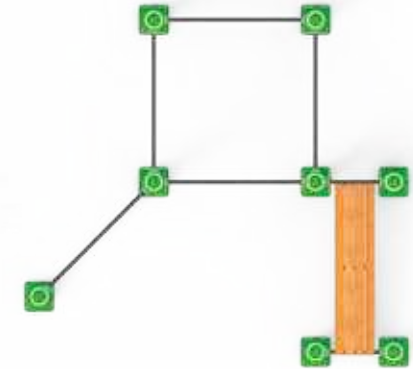

FP2431

ÜRÜN KODU	ÜRÜN ADI	YAŞ ARALIĞI	KAPASİTE	DÜŞME YÜKSEKLİĞİ	TEPE YÜKSEKLİĞİ	OTURUM ALANI	GÜVENLİK ALANI
Product Code	Product Name	Ages	Number of User	Drop Height (mm)	Hill Height (mm)	Seating Area (mm)	Safety Area (mm)
FP2426	Fitness Park Serisi / Fitness Park Series	+14	6	2300	2640	3280x3450	6280x6450
FP2427	Fitness Park Serisi / Fitness Park Series	+14	9	2450	2640	1550x4790	4550x7790
FP2428	Fitness Park Serisi / Fitness Park Series	+14	10	2400	2640	1550x6690	4550x9690

ÜRÜN KODU	ÜRÜN ADI	YAŞ ARALIĞI	KAPASİTE	DÜŞME YÜKSEKLİĞİ	TEPE YÜKSEKLİĞİ	OTURUM ALANI	GÜVENLİK ALANI
Product Code	Product Name	Ages	Number of User	Drop Height (mm)	Hill Height (mm)	Seating Area (mm)	Safety Area (mm)
FP2429	Fitness Park Serisi / Fitness Park Series	+14	6	1900	2640	2870x4310	5870x7310
FP2430	Fitness Park Serisi / Fitness Park Series	+14	7	2450	2640	2840x2940	5840x5940
FP2431	Fitness Park Serisi / Fitness Park Series	+14	7	2450	2640	2960x3150	5960x6150

FİTNESS PARK SERİSİ

Fitness Park Series

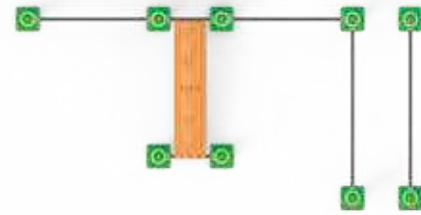

FP2432

FİTNESS PARK SERİSİ

Fitness Park Series

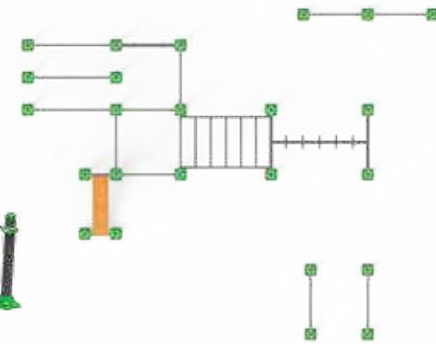

FP2435

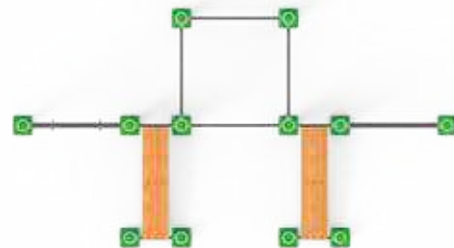

FP2433

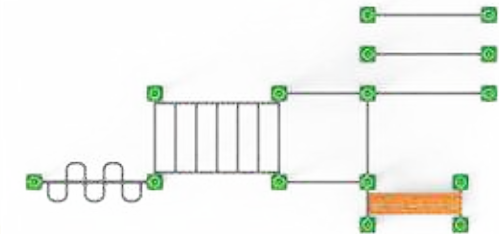

FP2436

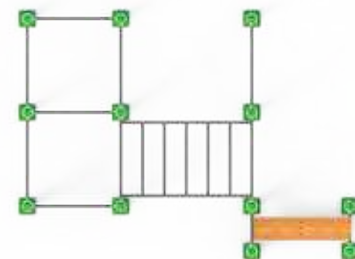

FP2434



FP2437

ÜRÜN KODU Product Code	ÜRÜN ADI Product Name	YAŞ ARALIĞI Ages	KAPASİTE Number of User	DÜŞME YÜKSEKLİĞİ Drop Height (mm)	TEPE YÜKSEKLİĞİ Hill Height (mm)	OTURUM ALANI Seating Area (mm)	GÜVENLİK ALANI Safety Area (mm)
FP2432	Fitness Park Serisi / Fitness Park Series	+14	5	2450	2640	2050x4140	5050x7140
FP2433	Fitness Park Serisi / Fitness Park Series	+14	9	2450	2640	2960x5540	5960x8540
FP2434	Fitness Park Serisi / Fitness Park Series	+14	11	2450	2640	3540x4860	6540x7860

ÜRÜN KODU Product Code	ÜRÜN ADI Product Name	YAŞ ARALIĞI Ages	KAPASİTE Number of User	DÜŞME YÜKSEKLİĞİ Drop Height (mm)	TEPE YÜKSEKLİĞİ Hill Height (mm)	OTURUM ALANI Seating Area (mm)	GÜVENLİK ALANI Safety Area (mm)
FP2435	Fitness Park Serisi / Fitness Park Series	+14	16	2460	2640	6870x8660	9870x11660
FP2436	Fitness Park Serisi / Fitness Park Series	+14	11	2450	2640	3390x7140	6390x10140
FP2437	Fitness Park Serisi / Fitness Park Series	+14	9	2640	3540	2070x6160	5070x9160

FİTNESS PARK SERİSİ

Fitness Park Series

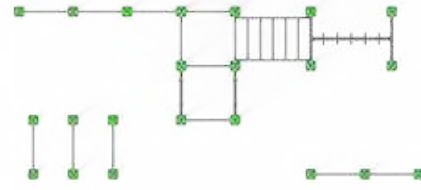

FP2438

FİTNESS PARK SERİSİ

Fitness Park Series

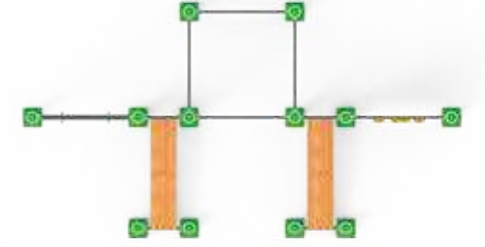

FP2441

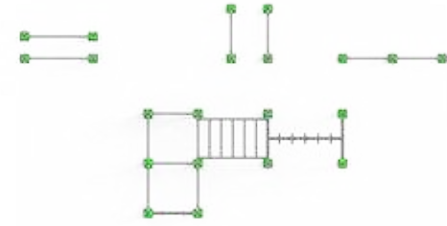

FP2439



FP2442

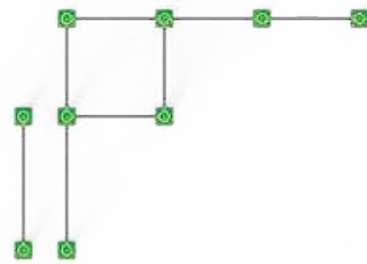

FP2440

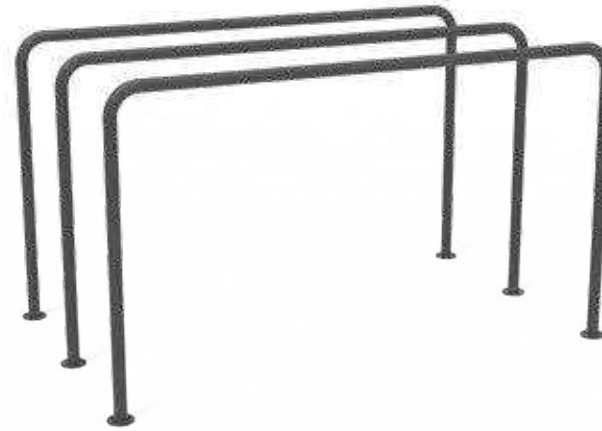

FP2443

ÜRÜN KODU Product Code	ÜRÜN ADI Product Name	YAŞ ARALIĞI Ages	KAPASİTE Number of User	DÜŞME YÜKSEKLİĞİ Drop Height (mm)	TEPE YÜKSEKLİĞİ Hill Height (mm)	OTURUM ALANI Seating Area (mm)	GÜVENLİK ALANI Safety Area (mm)
FP2438	Fitness Park Serisi / Fitness Park Series	+14	19	2460	2640	4230x10200	7230x13200
FP2439	Fitness Park Serisi / Fitness Park Series	+14	15	2170	2640	5730x11510	8730x14510
FP2440	Fitness Park Serisi / Fitness Park Series	+14	8	2340	2640	3370x4230	6370x7230

ÜRÜN KODU Product Code	ÜRÜN ADI Product Name	YAŞ ARALIĞI Ages	KAPASİTE Number of User	DÜŞME YÜKSEKLİĞİ Drop Height (mm)	TEPE YÜKSEKLİĞİ Hill Height (mm)	OTURUM ALANI Seating Area (mm)	GÜVENLİK ALANI Safety Area (mm)
FP2441	Fitness Park Serisi / Fitness Park Series	+14	9	2510	2640	2940x5540	5940x8540
FP2442	Fitness Park Serisi / Fitness Park Series	+14	9	2300	2640	1510x6070	4510x9070
FP2443	Fitness Park Serisi / Fitness Park Series	+14	2	1230	1230	1300x2140	3300x5140

FİTNESS PARK SERİSİ

Fitness Park Series

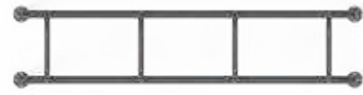
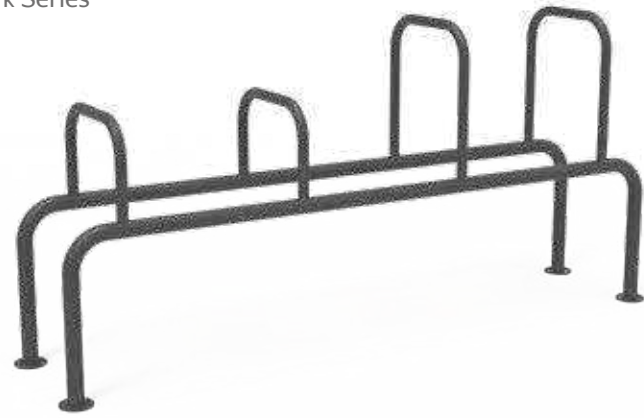

FP2444

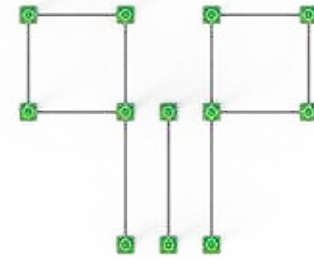

FP2445

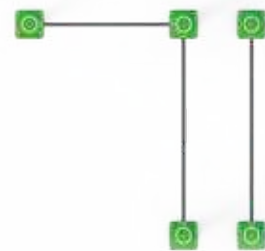

FP2446

ÜRÜN KODU Product Code	ÜRÜN ADI Product Name	YAŞ ARALIĞI Ages	KAPASİTE Number of User	DÜŞME YÜKSEKLİĞİ Drop Height (mm)	TEPE YÜKSEKLİĞİ Hill Height (mm)	OTURUM ALANI Seating Area (mm)	GÜVENLİK ALANI Safety Area (mm)
FP2444	Fitness Park Serisi / Fitness Park Series	+14	4	1000	1000	620x2050	3620x5050
FP2445	Fitness Park Serisi / Fitness Park Series	+14	11	1540	2640	3370x4070	6370x7070
FP2446	Fitness Park Serisi / Fitness Park Series	+14	2	1540	2640	2020x2120	5020x5120



FİTNESS SERİSİ
Fitness Series

FITNESS SERİSİ
Fitness Series



FITNESS SERİSİ
Fitness Series



ÜRÜN KODU Product Code	ÜRÜN ADI Product Name	YAŞ ARALIĞI Ages	KAPASİTE Number of User
FTN2501	Bacak Esnetme / Leg Stretch	+14	2
FTN2502	Makas / Leg Opening	+14	2
FTN2503	Bacak İtme / Leg Push	+14	2
FTN2504	Tekli Havada Yürüyüş / Single Walk in The Air	+14	1
FTN2505	İkili Havada Yürüyüş / Double Walk in The Air	+14	2
FTN2506	İkili Uzay Yürüme / Double Person Walking	+14	2

ÜRÜN KODU Product Code	ÜRÜN ADI Product Name	YAŞ ARALIĞI Ages	KAPASİTE Number of User
FTN2507	Tekli Uzay Yürüme / Single Person Walking	+14	1
FTN2508	İkili Bisiklet / Double Person Bicycle	+14	2
FTN2509	Meki İstasyonu / Push-up and Shuttle	+14	2
FTN2510	Bisiklet ve Step / Bicycle and Step	+14	2
FTN2511	Barfiks ve Çekis / Horizontal Bar and Pull Up	+14	3
FTN2512	Twist ve Bel Esnetme / Twist and Waist Stretch	+14	3

FITNESS SERİSİ
Fitness Series

FTN2513



Vücut Geliştirme
Body Building

FTN2514



Kondisyon Bisikleti
Condition Bicycle

FTN2515



Step ve Bel Esnetme
Step and Waist Stretch

FTN2516



Omuz ve Kol Çalıştırma
Arm and Shoulder Actuating

FTN2517



Eliptik Bisiklet
Elliptical Bicycle

FTN2518



Tambur ve Barfiks
Pull-up

FITNESS SERİSİ
Fitness Series

FTN2519



Step ve Twist
Step and Twist

FTN2520



El ve Ayak Bisikleti
Hand and Foot Bicycle

FTN2521



Vücut Esnetme
Body Stretch

FTN2522



İkili Bacak İtme
Double Leg Push

FTN2601



El ve Ayak Bisikleti (Özgür)
Hand and Foot Bicycle (Disabled)

FTN2601-1

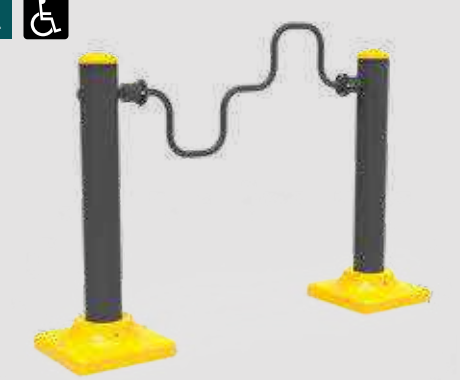

El Bisikleti (Özgür)
Hand Bicycle (Disabled)

ÜRÜN KODU Product Code	ÜRÜN ADI Product Name	YAŞ ARALIĞI Ages	KAPASİTE Number of User
FTN2513	Vücut Geliştirme / Body Building	+14	2
FTN2514	Kondisyon Bisikleti / Condition Bicycle	+14	1
FTN2515	Step ve Bel Esnetme / Step and Waist Stretch	+14	2
FTN2516	Omuz ve Kol Çalıştırma / Arm and Shoulder Actuating	+14	2
FTN2517	Eliptik Bisiklet / Elliptical Bicycle	+14	1
FTN2518	Tambur ve Barfiks / Pull-up	+14	2

ÜRÜN KODU Product Code	ÜRÜN ADI Product Name	YAŞ ARALIĞI Ages	KAPASİTE Number of User
FTN2519	Step ve Twist / Step and Twist	+14	2
FTN2520	El Ayak Bisikleti / Hand and Foot Bicycle	+14	1
FTN2521	Vücut Esnetme / Body Stretch	+14	1
FTN2522	İkili Bacak İtme / Double Leg Push	+14	2
FTN2601	El ve Ayak Bisikleti (Özgür) / Hand and Foot Bicycle (Disable)	+14	1
FTN2601-1	El Bisikleti (Özgür) / Hand Bicycle (Disabled)	+14	1

FITNESS SERİSİ
Fitness Series



FITNESS SERİSİ
Fitness Series

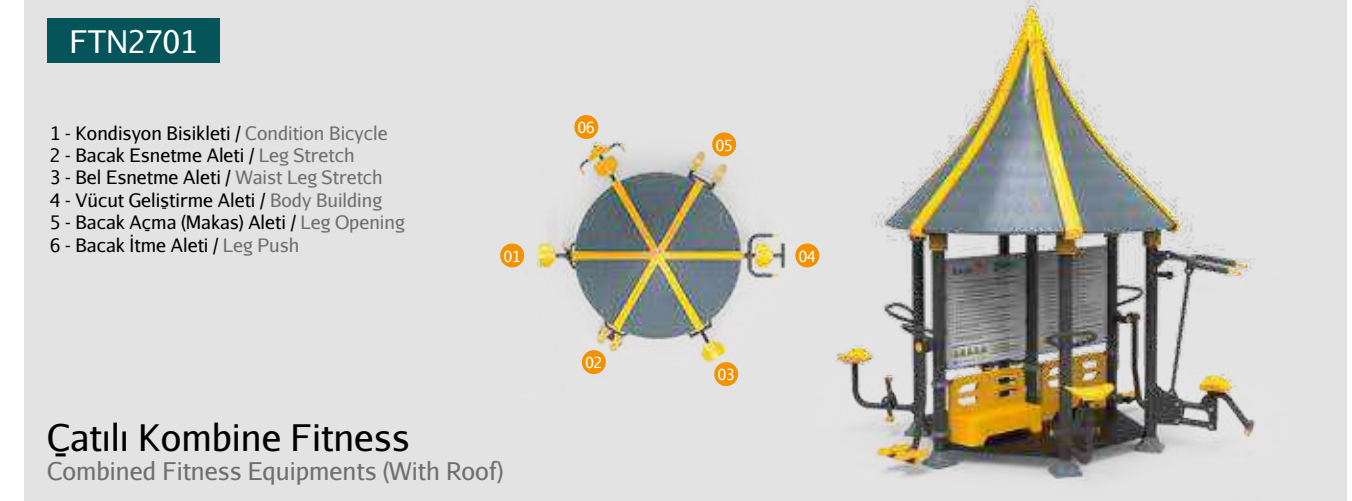

ÜRÜN KODU Product Code	ÜRÜN ADI Product Name	YAŞ ARALIĞI Ages	KAPASİTE Number of User
FTN2602	Kol Çalıştırma (Özgür) / Arm Actuate (Disabled)	+14	1
FTN2602-1	İkili Kol Çalıştırma (Özgür) / Double Arm Actuate (Disabled)	+14	2
FTN2603	Omuz ve Kol Çalıştırma (Özgür) / Arm and Shoulder Actuating (Disabled)	+14	2
FTN2604	Kol ve Ayak Çalıştırma (Özgür) / Hand and Foot Actuating (Disabled)	+14	1
FTN2605	Dik Halter (Özgür) / Barbell (Disabled)	+14	1
FTN2606	Eğik Halter (Özgür) / Leaning Barbell (Disabled)	+14	1

ÜRÜN KODU Product Code	ÜRÜN ADI Product Name	YAŞ ARALIĞI Ages	KAPASİTE Number of User
FTN2607	Vücut Geliştirme (Özgür) / Body Building (Disabled)	+14	2
FTN2608	Vücut Geliştirme (Özgür-Platformlu) / Body Building With Platform (Disabled)	+14	1
FTN2609	El ve Ayak Bisikleti (Özgür) / Hand and Foot Bicycle (Disabled)	+14	1
FTN2610	Denge Yürüyüşü (Özgür) / Balance Walking (Disabled)	+14	1
FTN2701	Çatılı Kombine Fitness / Combined Fitness Equipments (With Roof)	+14	6

FITNESS SERİSİ
Fitness Series

FTN2801



Kombine Çocuk Fitness Set 01
Combined Child Fitness Set 01

FTN2802



Kombine Çocuk Fitness Set 02
Combined Child Fitness Set 02

FTN2803



Çocuk Bacak Esnetme
Child Leg Stretch

FTN2804



Çocuk Makas
Child Leg Opening

FTN2805



Çocuk Tekli Havada Yürüyüş
Child Single Walk in the Air

FTN2806



Çocuk İkili Uzak Yürüme
Child Double Walking

FITNESS SERİSİ
Fitness Series

FTN2807



Çocuk Twist ve Bel Esnetme
Child Twist and Waist Stretch

FTN2808



Çocuk Kondisyon Bisikleti
Child Condition Bicycle

FTN2901



Panolu Makas
Leg Opening (With The Panel)

FTN2902



Panolu Havada İkili Yürüyüş
Double Walk in The Air (With The Panel)

FTN2903



Panolu İkili Bisiklet
Double Person Bicycle (With The Panel)

FTN2904



Panolu Vücut Geliştirme
Body Building (With The Panel)

ÜRÜN KODU Product Code	ÜRÜN ADI Product Name	YAŞ ARALIĞI Ages	KAPASİTE Number of User
FTN2801	Kombine Çocuk Fitness Set 01 / Combined Child Fitness Set 01	5-14	4
FTN2802	Kombine Çocuk Fitness Set 02 / Combined Child Fitness Set 02	5-14	7
FTN2803	Çocuk Bacak Esnetme / Child Leg Stretch	5-14	2
FTN2804	Çocuk Makas / Child Leg Opening	5-14	2
FTN2805	Çocuk Tekli Havada Yürüyüş / Child Single Walk in the Air	5-14	1
FTN2806	Çocuk İkili Uzak Yürüme / Child Double Walking	5-14	2

ÜRÜN KODU Product Code	ÜRÜN ADI Product Name	YAŞ ARALIĞI Ages	KAPASİTE Number of User
FTN2807	Çocuk Twist ve Bel Esnetme / Child Twist and Waist Stretch	5-14	2
FTN2808	Çocuk Kondisyon Bisikleti / Child Condition Bicycle	5-14	1
FTN2901	Panolu Makas / Leg Opening (With The Panel)	+14	2
FTN2902	Panolu Havada İkili Yürüyüş / Double Walk in The Air (With The Panel)	+14	2
FTN2903	Panolu İkili Bisiklet / Double Person Bicycle (With The Panel)	+14	2
FTN2904	Panolu Vücut Geliştirme / Body Building (With The Panel)	+14	2

FITNESS SERİSİ
Fitness Series

FTN2905



Panolu Twist ve Bel Esnetme
Twist and Waist Stretch (With The Pannel)

FTN2906



Panolu Sırt ve Karın Kası Geliştirme
Back and Waist Stretch (With The Pannel)

FTN2907



Panolu İkili Kol Çalıştırma
Double Arm Actuate (With The Pannel)

FTN2908



Panolu Sırt Çalıştırma ve Twist
Back Stretch and Twist (With The Pannel)

FTN2909



Panolu İkili Uzay Yürüme
Double Person Walking (With The Pannel)

FTN2910



Panolu Üçlü Fitness Set 01
Treangle Fitness Set With The Pannel 01

FITNESS SERİSİ
Fitness Series

FTN2911

Bel Esnetme / Waist Stretch
Vücut Geliştirme / Body Building
Kondüsyon Bisikleti / Condition Bicycle



Panolu Üçlü Fitness Set 02
Treangle Fitness Set With The Pannel 02

FTN2912

Tekli Havada Yürüyüş / Single Walking in the Air
Tekli Uzay Yürüme / Single Walking
Eliptik Bisiklet / Elliptical Bicycle



Panolu Üçlü Fitness Set 03
Treangle Fitness Set With The Pannel 03

FTN2913

Step / Step
Twist / Twist
Vücut Esnetme / Body Stretch



Panolu Üçlü Fitness Set 04
Treangle Fitness Set With The Pannel 04



ÜRÜN KODU Product Code	ÜRÜN ADI Product Name	YAŞ ARALIĞI Ages	KAPASİTE Number of User
FTN2905	Panolu Twist ve Bel Esnetme / Twist and Waist Stretch (With The Pannel)	+14	2
FTN2906	Panolu Sırt ve Karın Kası Geliştirme / Back and Waist Stretch (With The Pannel)	+14	2
FTN2907	Panolu İkili Kol Çalıştırma / Double Arm Actuate (With The Pannel)	+14	2
FTN2908	Panolu Sırt Çalıştırma ve Twist / Back Stretch and Twist (With The Pannel)	+14	2
FTN2909	Panolu İkili Uzay Yürüme / Double Person Walking (With The Pannel)	+14	2
FTN2910	Panolu Üçlü Fitness Set 01 / Treangle Fitness Set With The Pannel 01	+14	3

ÜRÜN KODU Product Code	ÜRÜN ADI Product Name	YAŞ ARALIĞI Ages	KAPASİTE Number of User
FTN2911	Panolu Üçlü Fitness Set 02 / Treangle Fitness Set With The Pannel 02	+14	3
FTN2912	Panolu Üçlü Fitness Set 03 / Treangle Fitness Set With The Pannel 03	+14	3
FTN2913	Panolu Üçlü Fitness Set 04 / Treangle Fitness Set With The Pannel 04	+14	3

FITNESS SERİSİ
Fitness Series

PFTN3901



Bacak Esnetme
Leg Stretch

PFTN3902



Twist
Twist

PFTN3903



Havada Yürüyüş
Walk in the Air

PFTN3904



Eliptik Bisiklet
Elliptical Bicycle

PFTN3905



Bacak İtme
Leg Push

PFTN3906



Kol Çekme
Arm Pull

FITNESS SERİSİ
Fitness Series

PFTN3907



Dips ve Karın Çalıştırma
Dips and Abdominal Work

PFTN3908



Vücut Çekme
Body Pull

PFTN3909



Vücut İtme
Body Push

PFTN3910



Mekik İstasyonu
Push Up and Shuttle

PFTN3911



Kürek Çekme
Cardio Tool

ÜRÜN KODU Product Code	ÜRÜN ADI Product Name	YAŞ ARALIĞI Ages	KAPASİTE Number of User
PFTN3901	Bacak Esnetme / Leg Stretch	+14	1
PFTN3902	Twist / Twist	+14	1
PFTN3903	Havada Yürüyüş / Walk in the Air	+14	1
PFTN3904	Eliptik Bisiklet / Elliptical Bicycle	+14	1
PFTN3905	Bacak İtme / Leg Push	+14	1
PFTN3906	Kol Çekme / Arm Pull	+14	1

ÜRÜN KODU Product Code	ÜRÜN ADI Product Name	YAŞ ARALIĞI Ages	KAPASİTE Number of User
PFTN3907	Dips ve Karın Çalıştırma / Dips and Abdominal Work	+14	2
PFTN3908	Vücut Çekme / Body Pull	+14	1
PFTN3909	Vücut İtme / Body Push	+14	1
PFTN3910	Mekik İstasyonu / Push Up and Shuttle	+14	1
PFTN3911	Kürek Çekme / Cardio Tool	+14	1

FITNESS SERİSİ
Fitness Series

6'lı Set
11 Kişi



Sete Dahil Olan Ürünler
Fitness Tools in the Set

FTN2501
FTN2502
FTN2503
FTN2504
FTN2508
FTN2509

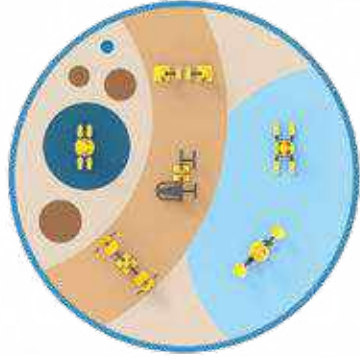

FS4001

ÜRÜN KODU Product Code	ÜRÜN ADI Product Name	YAŞ ARALIĞI Ages	KAPASİTE Number of User	DÜŞME YÜKSEKLİĞİ Drop Height (mm)	TEPE YÜKSEKLİĞİ Hill Height (mm)	OTURUM ALANI Seating Area (mm)	GÜVENLİK ALANI Safety Area (m2)
FS4001	Fitness Serisi 6'lı / Fitness Series 6	+14	11	-	Daire	Ø6000-30 (m2)	Ø9000-65 (m2)
FS4001	Fitness Serisi 6'lı / Fitness Series 6	+14	11	-	Kare	5000x5500-30 (m2)	8000x8500-68 (m2)

FITNESS SERİSİ
Fitness Series

10'lu Set
21 Kişi



Sete Dahil Olan Ürünler
Fitness Tools in the Set

FTN2501
FTN2502
FTN2503
FTN2504
FTN2506
FTN2509
FTN2510
FTN2511
FTN2512
FTN2516

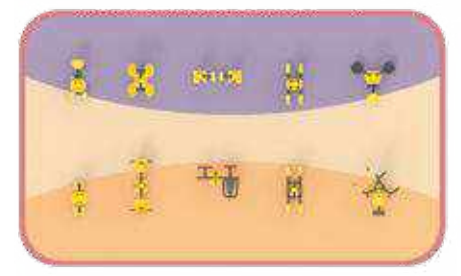
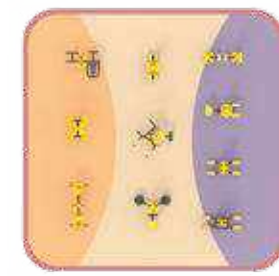

FS4002

ÜRÜN KODU Product Code	ÜRÜN ADI Product Name	YAŞ ARALIĞI Ages	KAPASİTE Number of User	DÜŞME YÜKSEKLİĞİ Drop Height (mm)	TEPE YÜKSEKLİĞİ Hill Height (mm)	OTURUM ALANI Seating Area (mm)	GÜVENLİK ALANI Safety Area (m2)
FS4003	Fitness Serisi 10'lu / Fitness Series 10	+14	21	-	Daire	Ø8000-50 (m2)	Ø11000-95 (m2)
FS4003	Fitness Serisi 10'lu / Fitness Series 10	+14	21	-	Kare	7000x7000-50 (m2)	10000x10000-100 (m2)
FS4003	Fitness Serisi 10'lu / Fitness Series 10	+14	21	-	Dikdörtgen	5000x10500-55 (m2)	8000x13500-110 (m2)

FITNESS SERİSİ
Fitness Series

6'lı Set
12 Kişi



Sete Dahil Olan Ürünler
Fitness Tools in the Set

FTN2901
FTN2902
FTN2903
FTN2904
FTN2905
FTN2907

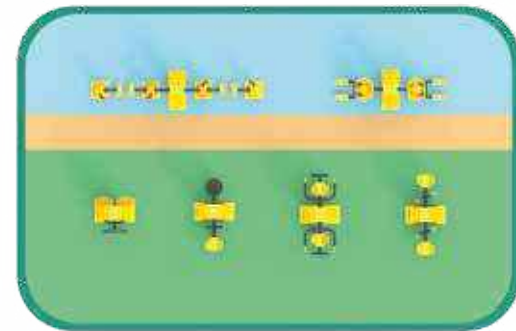
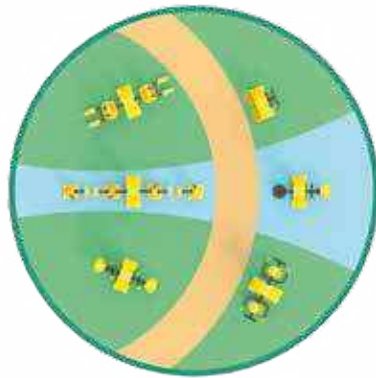

FS4002

ÜRÜN KODU Product Code	ÜRÜN ADI Product Name	YAŞ ARALIĞI Ages	KAPASİTE Number of User	DÜŞME YÜKSEKLİĞİ Drop Height (mm)	TEPE YÜKSEKLİĞİ Hill Height (mm)	OTURUM ALANI Seating Area (mm)	GÜVENLİK ALANI Safety Area (mm)
FS4002	Panolu Fitness Serisi 6'lı / Board Fitness Series 6	+14	12	-	Daire	Ø7000-40 (m2)	Ø10000-80 (m2)
FS4002	Panolu Fitness Serisi 6'lı / Board Fitness Series 6	+14	12	-	Dikdörtgen	4000x8000-32 (m2)	7000x11000-80 (m2)

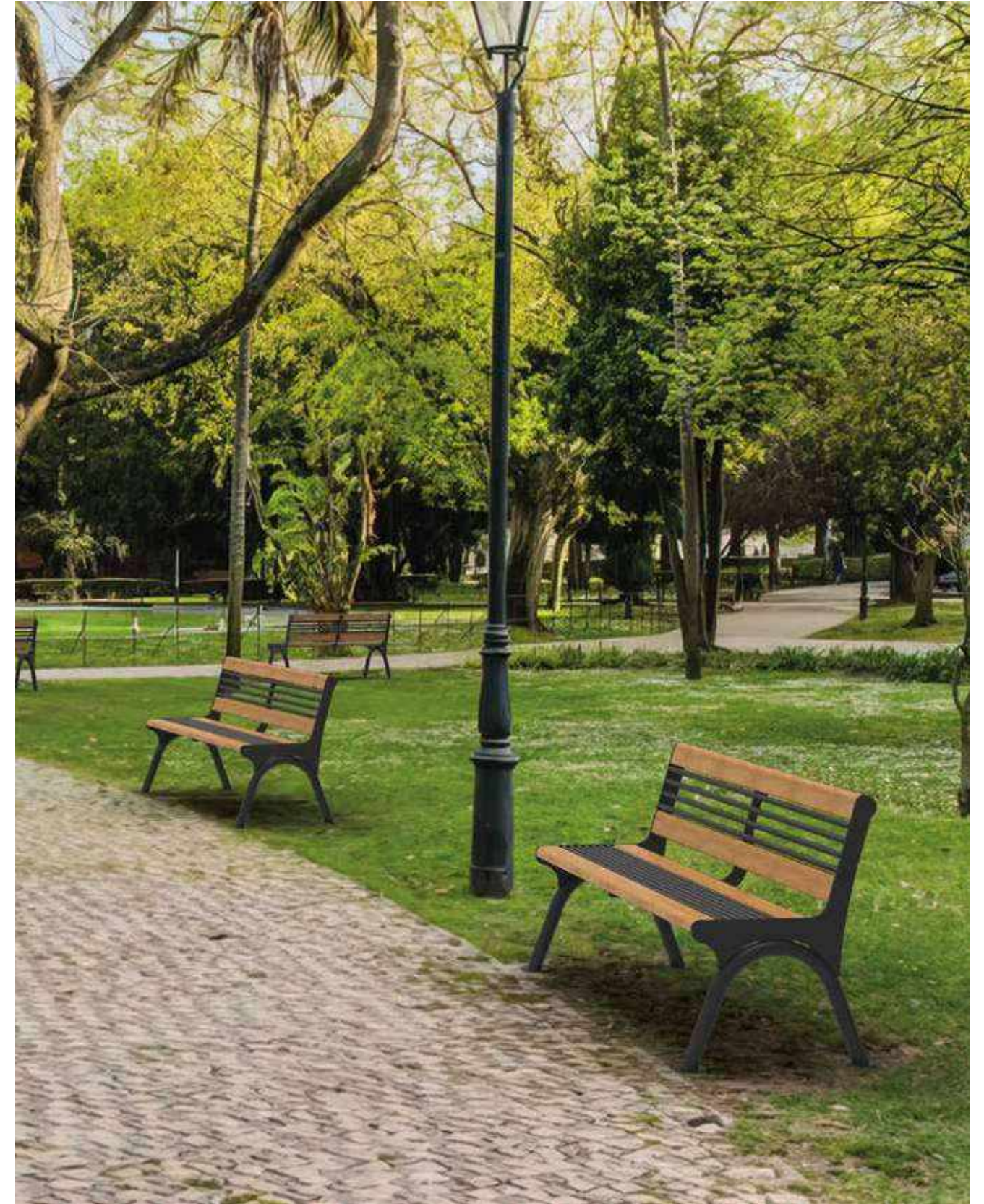

KENT EKİPMANLARI
URBAN EQUIPMENT

PARK SERİSİ

Park Series

PS4101



Basketbol Potası (Metal)
Basketball Hoop (Metal)

PS4102



Basketbol Potası (Campanya)
Basketball Hoop (Plexi Glass)

PS4103

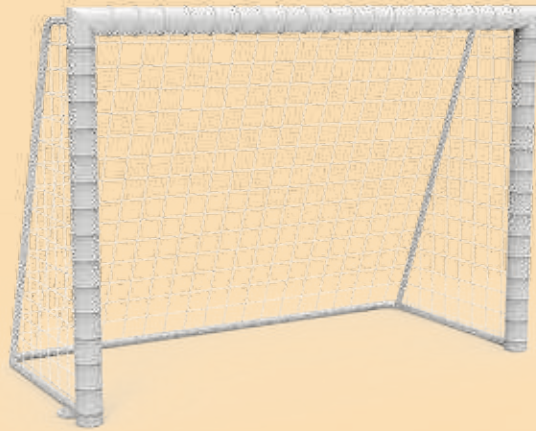

Mini Futbol Kalesi
Mini Football Tower

PS4104

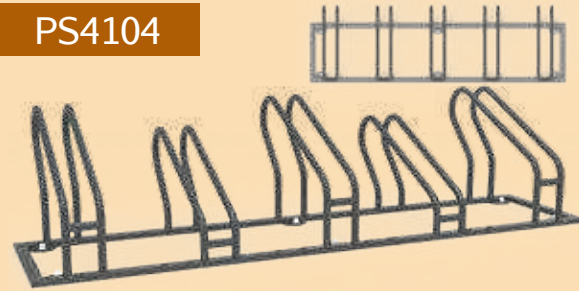

Bisiklet Parkı 1
Bicycle Park 1

PS4105

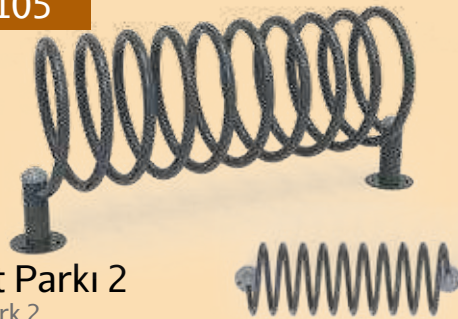

Bisiklet Parkı 2
Bicycle Park 2

KAMERİYE SERİSİ

Gazebo Series

KMR3001

Teknik Özellikler
Technical Specification

İç Alan Ölçüsü / Inside Dimensions : 2,5 x 2,5 mt.
Dış Alan Ölçüsü / Outside Dimensions : 3 x 3 mt.
Fonksiyonlar / Properties : Masa + Sedir / Bench + Table
Ahşap Cinsi / Material : Sarı Çam / Yellow Pine
Ahşap Boya / Wood Paint : Vakum Eprenye / Vacuum Impregnation



KMR3002



Teknik Özellikler
Technical Specification

İç Alan Ölçüsü / Inside Dimensions : 4 x 4 mt.
Dış Alan Ölçüsü / Outside Dimensions : 4,5 x 4,5 mt.
Fonksiyonlar / Properties : Sedir / Bench
Ahşap Cinsi / Material : Sarı Çam / Yellow Pine
Ahşap Boya / Wood Paint : Vakum Eprenye / Vacuum Impregnation

KMR3003

Teknik Özellikler
Technical Specification

İç Alan Ölçüsü / Inside Dimensions : 1,5 x 2 mt.
Dış Alan Ölçüsü / Outside Dimensions : 2 x 2,4 mt.
Fonksiyonlar / Properties : Masa + Sedir / Bench + Table
Ahşap Cinsi / Material : Sarı Çam / Yellow Pine
Ahşap Boya / Wood Paint : Vakum Eprenye / Vacuum Impregnation



ÜRÜN KODU Product Code	ÜRÜN ADI Product Name	YAŞ ARALIĞI Ages	KAPASİTE Number of User	DÜŞME YÜKSEKLİĞİ Drop Height (mm)	TEPE YÜKSEKLİĞİ Hill Height (mm)	OTURUM ALANI Seating Area (mm)	GÜVENLİK ALANI Safety Area (m2)
FS4101	Basketbol Potası (Metal) / Basketball Hoop (Metal)	-	-	-	3930	1800x2040	-
FS4102	Basketbol Potası (Campanya) / Basketball Hoop (Plexi Glass)	-	-	-	3960	1800x2080	-
FS4103	Mini Futbol Kalesi / Mini Football Tower	-	-	-	1340	940x1930	-
FS4104	Bisiklet Parkı 1 / Bicycle Park 1	-	-	-	260	600x3000	-
FS4105	Bisiklet Parkı 2 / Bicycle Park 2	-	-	-	740	550x1700	-

BANK SERİSİ

Bank Series



BANK SERİSİ

Bank Series



ÇÖP KOVASI SERİSİ Trash Can Series

TCS3201

Teknik Özellikler
Technical Specification

Ebat : 28 x 52 x 105
Metal Cinsi : Boru Profil
Metal Boya : Elektrostatik



TCS3202

Teknik Özellikler
Technical Specification

Ebat : 28 x 52 x 105
Metal Cinsi : Boru Profil
Metal Boya : Elektrostatik



TCS3203

Teknik Özellikler
Technical Specification

Kova Ebat : 260 x 380 x 490 mm
Dış Ölçüler : 260 x 460 x 1000 mm
Metal Boya : 304 Kalite 4N PC



Krom Nikel

TCS3204

Teknik Özellikler
Technical Specification

Ebat : 52 x 52 x 78
Ahşap Cinsi : İthal Sarı Çam
Metal Cinsi : Boru Profil
Metal Boya : Elektrostatik
Ahşap Boya : Vakum Eprenye



TCS3205

Teknik Özellikler
Technical Specification

Ebat : 52 x 55 x 72
Metal Cinsi : Silme Demir
Ahşap Cinsi : İthal Sarı Çam
Metal Boya : Elektrostatik
Ahşap Boya : Vakum Eprenye



TCS3206

Teknik Özellikler
Technical Specification

Ebat : 45 x 60 x 100
Ahşap Cinsi : İthal Sarı Çam
Metal Boya : Elektrostatik
Ahşap Boya : Vakum Eprenye



ÇÖP KOVASI SERİSİ Trash Can Series

TCS3207

Teknik Özellikler
Technical Specification

Ebat : 45 x 45 x 95
Metal Cinsi : Silme Demir ve Boru Profil
Ahşap Cinsi : İthal Sarı Çam
Metal Boya : Elektrostatik
Ahşap Boya : Vakum Eprenye



TCS3208

Teknik Özellikler
Technical Specification

Ebat : 90 x 90 x 120
Metal Cinsi : Silme Demir ve Boru Profil
Ahşap Cinsi : İthal Sarı Çam
Metal Boya : Elektrostatik
Ahşap Boya : Vakum Eprenye



TCS3210

Teknik Özellikler
Technical Specification

Ebat : 55 x 130 x 72
Metal Cinsi : Silme Demir
Ahşap Cinsi : İthal Sarı Çam
Metal Boya : Elektrostatik
Ahşap Boya : Vakum Eprenye



TCS3211

Teknik Özellikler
Technical Specification

Ebat : 40 x 100 x 80
Metal Cinsi : Silme Demir
Ahşap Cinsi : İthal Sarı Çam
Metal Boya : Elektrostatik
Ahşap Boya : Vakum Eprenye

